

FORMES OPTIQUES  
OPTICAL SHAPES  
FORMAS ÓPTICAS  
OPTISCHE FORMEN  
FORMAS ÓPTICAS

M-0 / M-0P / M-1 / M-2 / M-3 / M-4 / M-5 / M-5C  
M-7 / M-8 / M-21 / M-22 / M-25 / M-52 / M-53  
M-56 / M-57-57C / M-58-58C / M-59-59C  
M-60-60C / M-61-61C / M-62-62C / M-63-63C  
M-64-64C / M-71 / M-81 / M-501-501C  
M-502-502C / M-503 / M-505

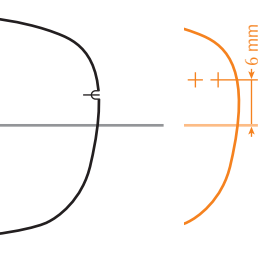

M-22	M-21	M-503	M-0/OP/1/2/3/4/5	Pont traditionnel Traditional bridge	Pont W nu W bridge bare	Pont M-8 / M-5C M-8 / M-5C bridge	M-5C / M-8 / 57C 58C / 59C / 60C / 61C 62C / 63C / 64C / 81 501C / 502C
M-25	M-505	7 / 52 / 53 / 56 / 57 58 / 59 / 60 / 61 / 62 63 / 64 / 71 / 501 / 502	Pont W avec selle clipsée W bridge with clipped saddle ou Pont P/P Bridge				

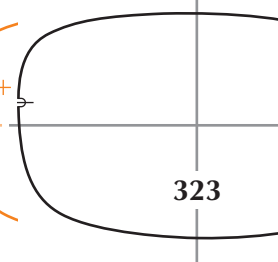
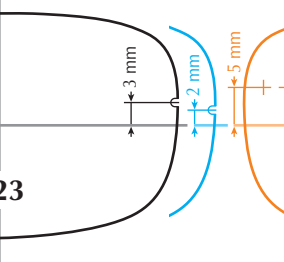
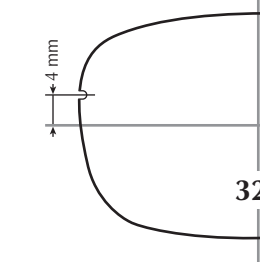
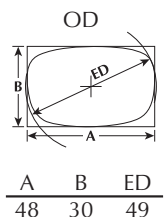
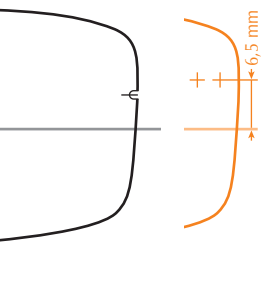
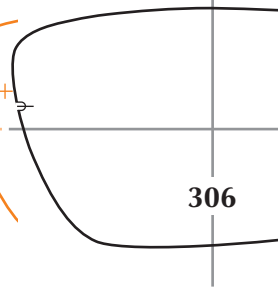
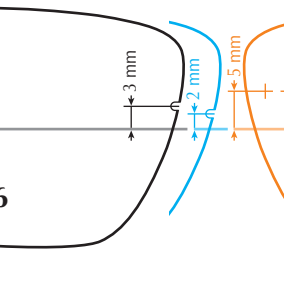
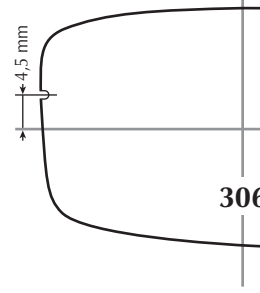
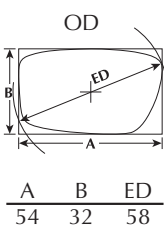
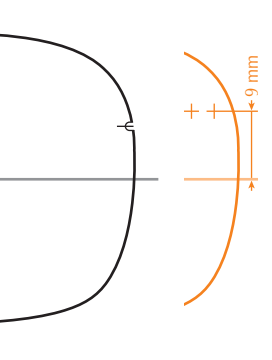
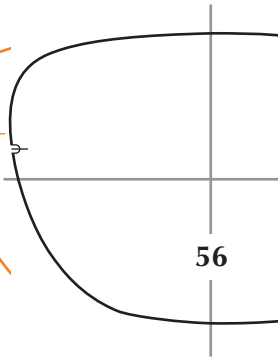
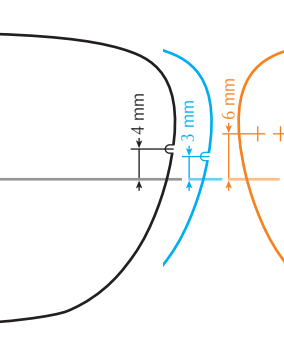
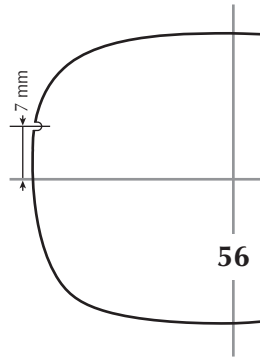
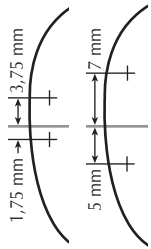
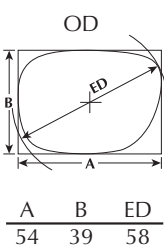
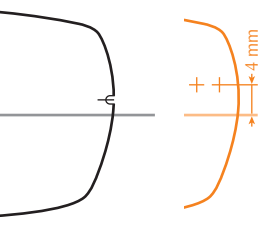
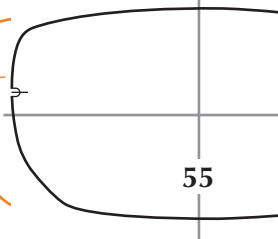
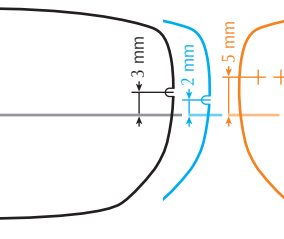
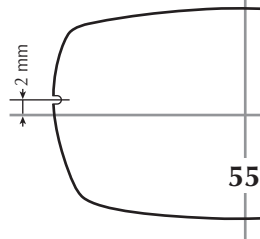
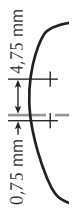
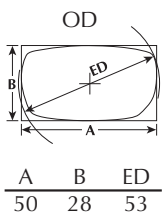
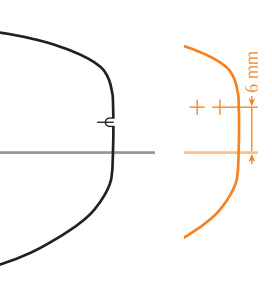
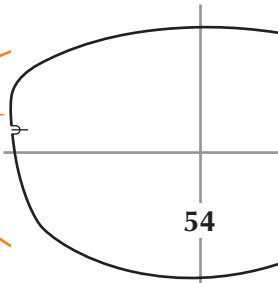
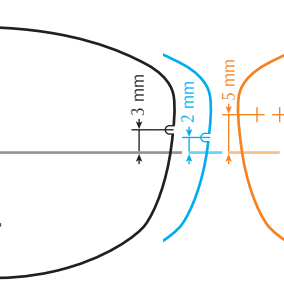
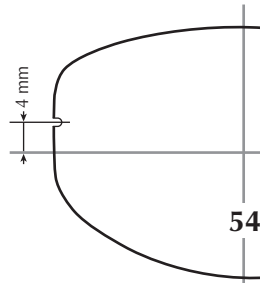
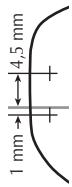
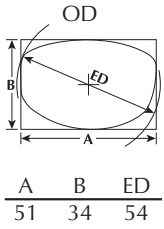

Toutes ces informations sont communiquées à titre indicatif et doivent être adaptées à la forme du nez du porteur.  
All infos provided must be adapted to shape and size of the patient's nose.

⚠ Attention : certaines imprimantes peuvent ne pas reproduire ce document à l'échelle exacte.  
Note: some printers may not duplicate this document at the correct scale.



M-22	M-21	M-503	M-0/OP/1/2/3/4/5	Pont traditionnel Traditional bridge	Pont W nu W bridge bare	Pont M-8 / M-5C M-8 / M-5C bridge	M-5C / M-8 / 57C 58C / 59C / 60C / 61C 62C / 63C / 64C / 81 501C / 502C
M-25	M-505	7 / 52 / 53 / 56 / 57 58 / 59 / 60 / 61 / 62 63 / 64 / 71 / 501 / 502	Pont W avec selle clipsée W bridge with clipped saddle ou Pont P/P Bridge				

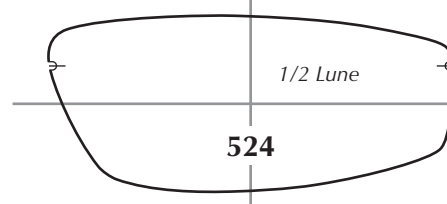
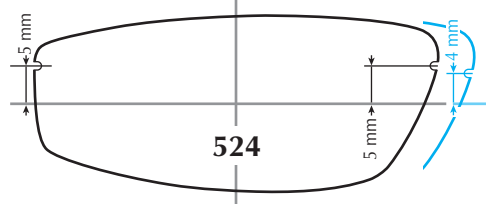
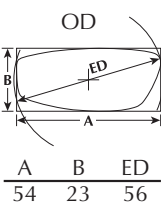
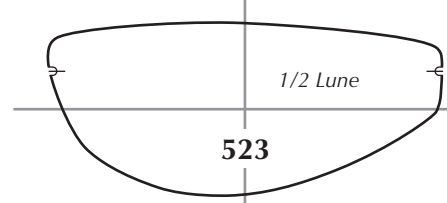
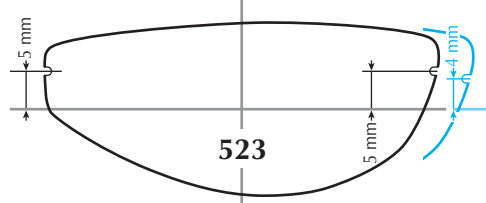
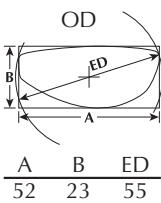
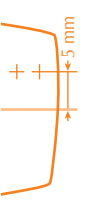
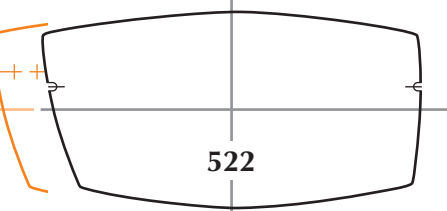
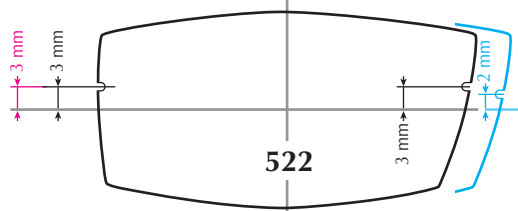
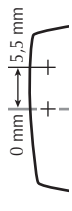
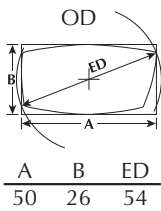
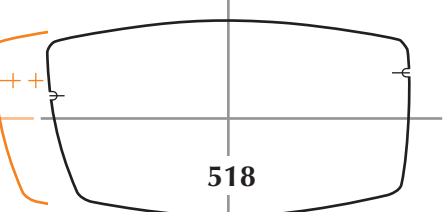
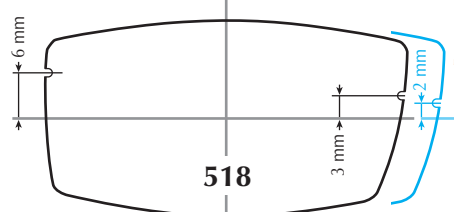
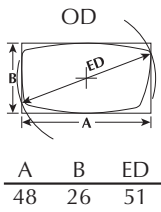
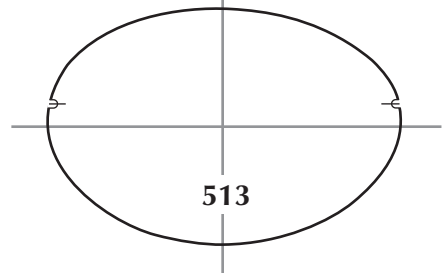
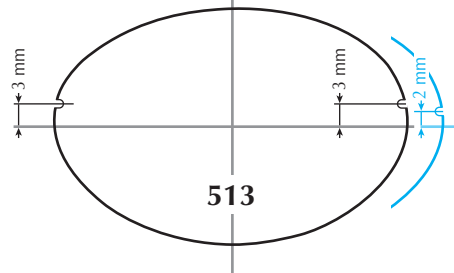
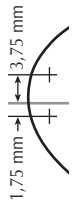
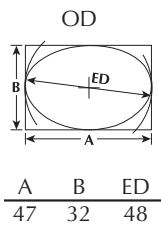
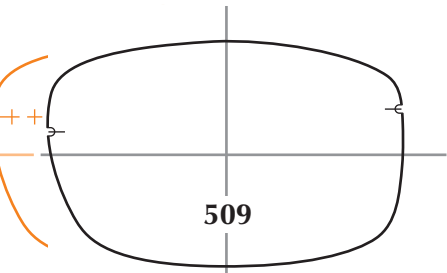
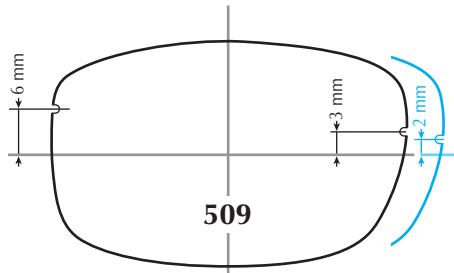
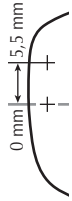
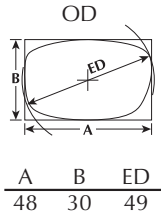

Toutes ces informations sont communiquées à titre indicatif et doivent être adaptées à la forme du nez du porteur.  
All infos provided must be adapted to shape and size of the patient's nose.

⚠ Attention : certaines imprimantes peuvent ne pas reproduire ce document à l'échelle exacte.  
Note: some printers may not duplicate this document at the correct scale.



M-22 M-21 **M-503** M-0/OP/1/2/3/4/5 Pont traditionnel / Traditional bridge  
 M-25 **M-505** 7/52/53/56/57 Pont W avec selle clipsée / W bridge with clipped saddle  
 58/59/60/61/62 ou Pont P/P Bridge  
 Pont W nu / W bridge bare  
 Pont M-8 / M-5C / M-8 / M-5C bridge  
 M-5C / M-8 / 57C / 58C / 59C / 60C / 61C / 62C / 63C / 64C / 81 / 501C / 502C

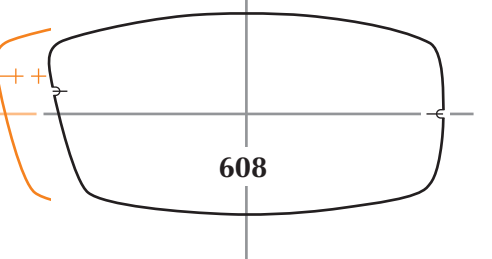
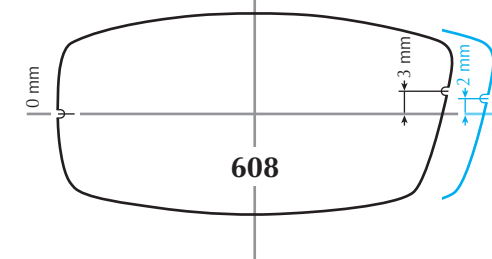
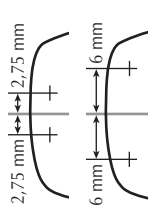
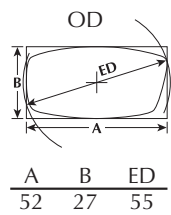
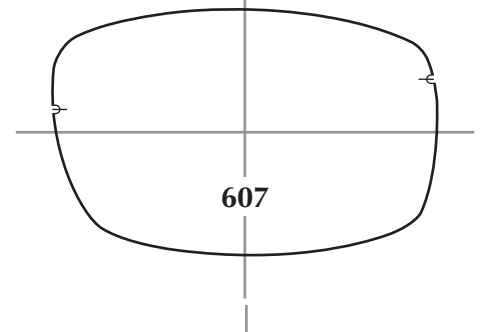
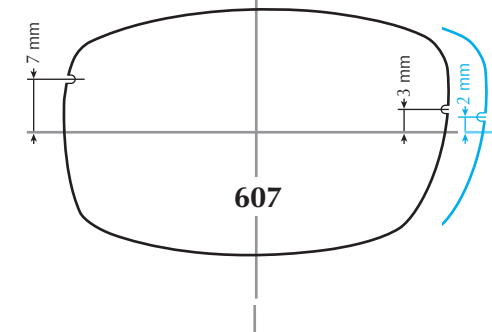
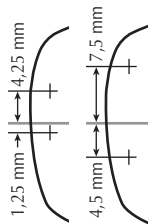
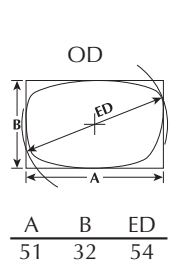
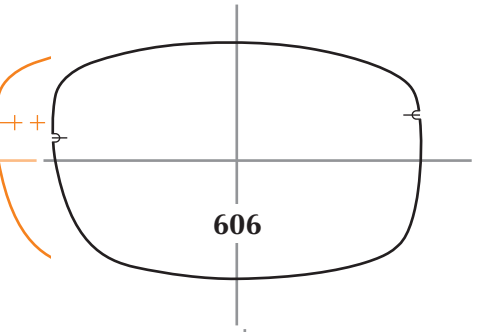
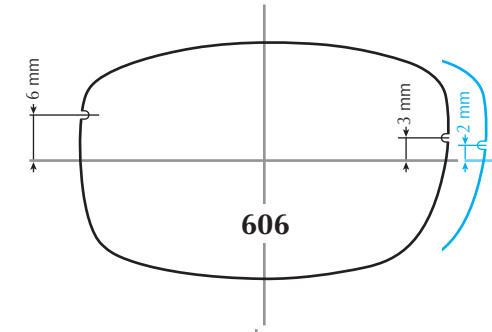
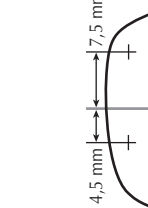
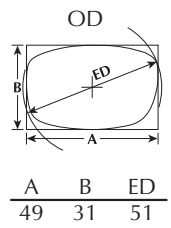
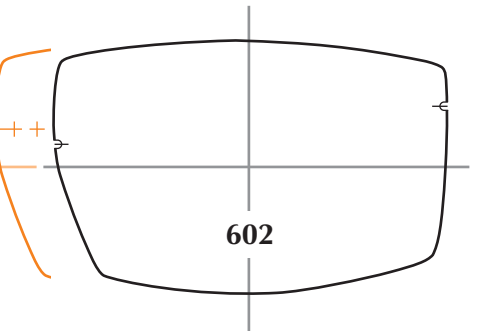
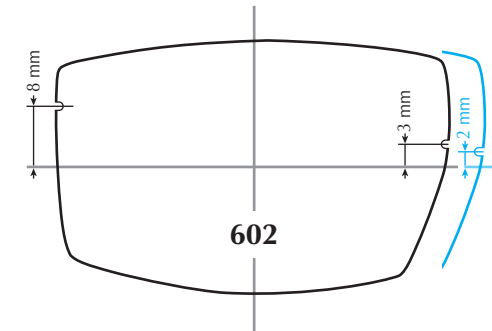
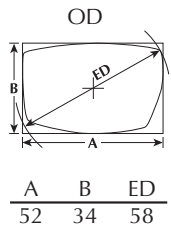
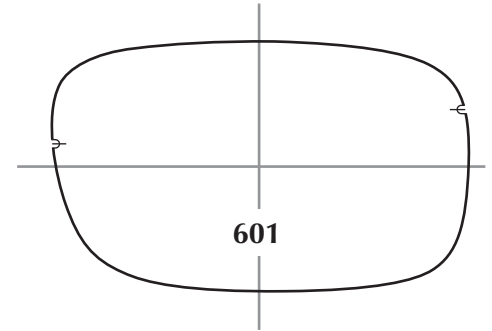
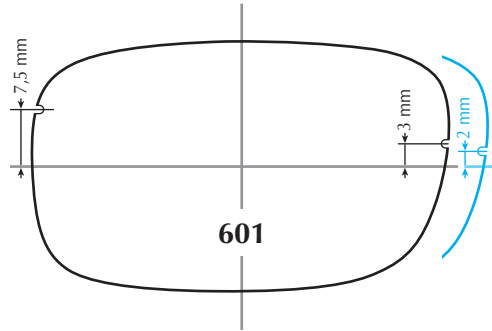
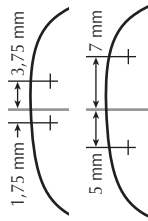
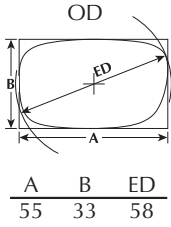

Toutes ces informations sont communiquées à titre indicatif et doivent être adaptées à la forme du nez du porteur.  
 All infos provided must be adapted to shape and size of the patient's nose.

Attention : certaines imprimantes peuvent ne pas reproduire ce document à l'échelle exacte.  
 Note: some printers may not duplicate this document at the correct scale.



M-22	M-21	M-503	M-0 / OP / 1 / 2 / 3 / 4 / 5	Pont traditionnel Traditional bridge	Pont W nu W bridge bare	Pont M-8 / M-5C M-8 / M-5C bridge	M-5C / M-8 / 57C 58C / 59C / 60C / 61C 62C / 63C / 64C / 81 501C / 502C
M-25	M-505	7 / 52 / 53 / 56 / 57 58 / 59 / 60 / 61 / 62 63 / 64 / 71 / 501 / 502	Pont W avec selle clipsée W bridge with clipped saddle ou Pont P/P Bridge				

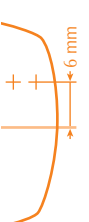
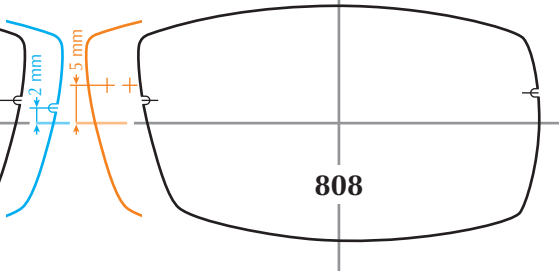
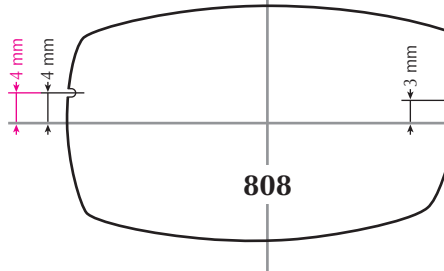
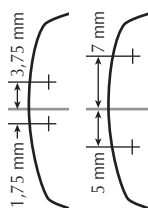
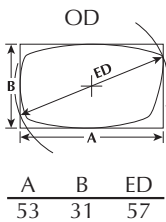
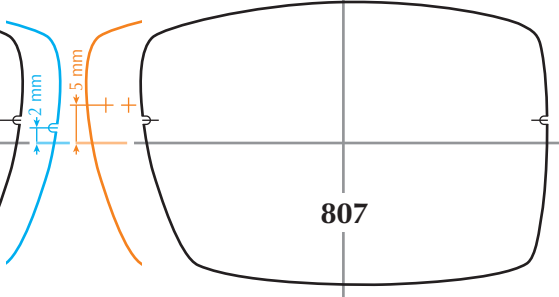
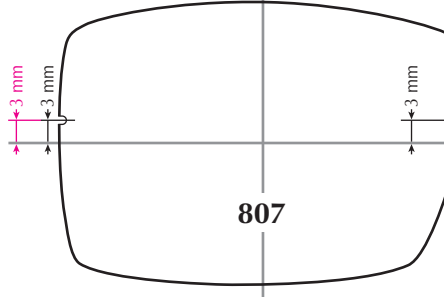
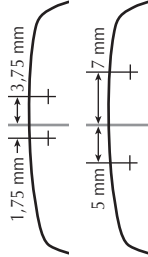
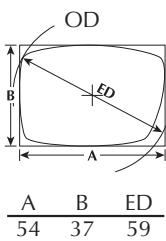
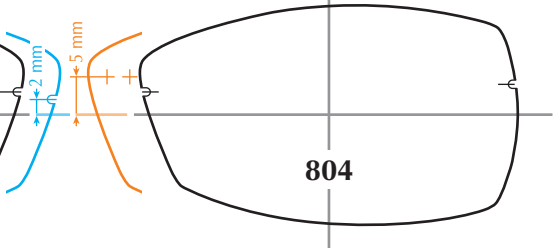
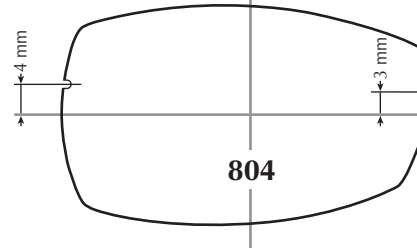
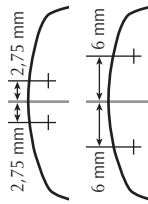
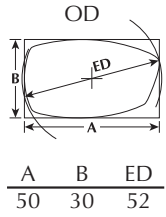
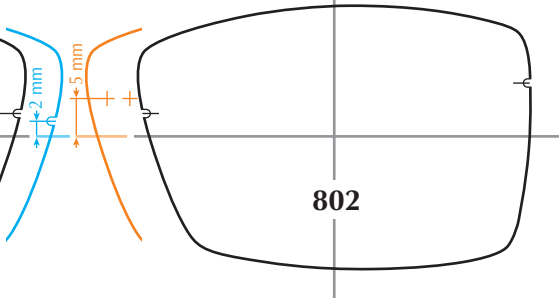
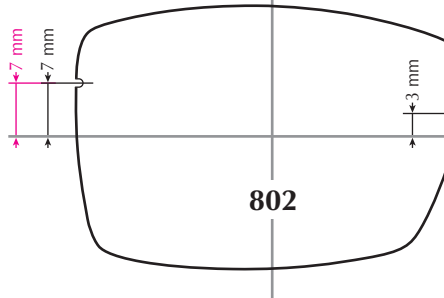
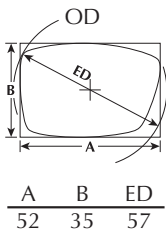
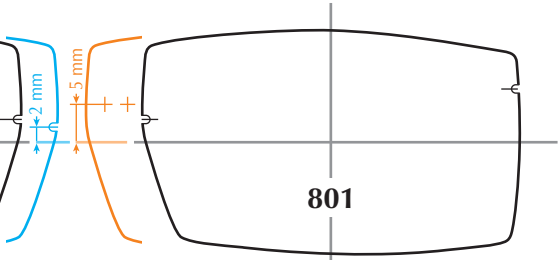
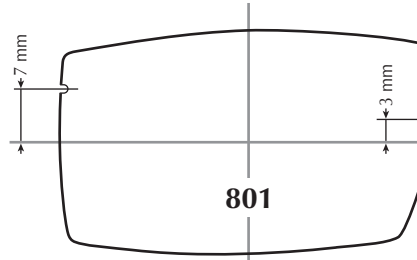
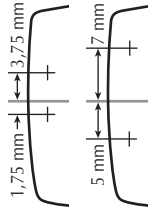
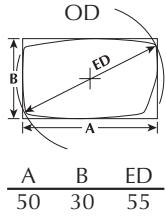

Toutes ces informations sont communiquées à titre indicatif et doivent être adaptées à la forme du nez du porteur.  
All infos provided must be adapted to shape and size of the patient's nose.

⚠ Attention : certaines imprimantes peuvent ne pas reproduire ce document à l'échelle exacte.  
Note: some printers may not duplicate this document at the correct scale.



M-22 M-21 M-503 M-0/OP/1/2/3/4/5 Pont traditionnel / Traditional bridge Pont W avec selle clipsée / W bridge with clipped saddle ou Pont P/P Bridge

M-25 M-505 7/52/53/56/57 58/59/60/61/62 63/64/71/501/502

Pont W nu / W bridge bare

Pont M-8 / M-5C / M-8 / M-5C bridge

M-5C / M-8 / 57C / 58C / 59C / 60C / 61C / 62C / 63C / 64C / 81 / 501C / 502C

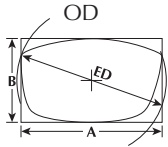

A	B	ED
52	31	55

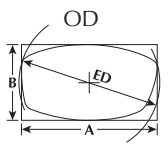

A	B	ED
50	28	52

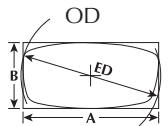

A	B	ED
50	24	52

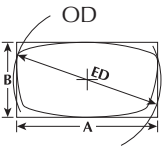

A	B	ED
52	28	55

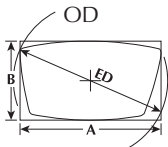

A	B	ED
52	29	57

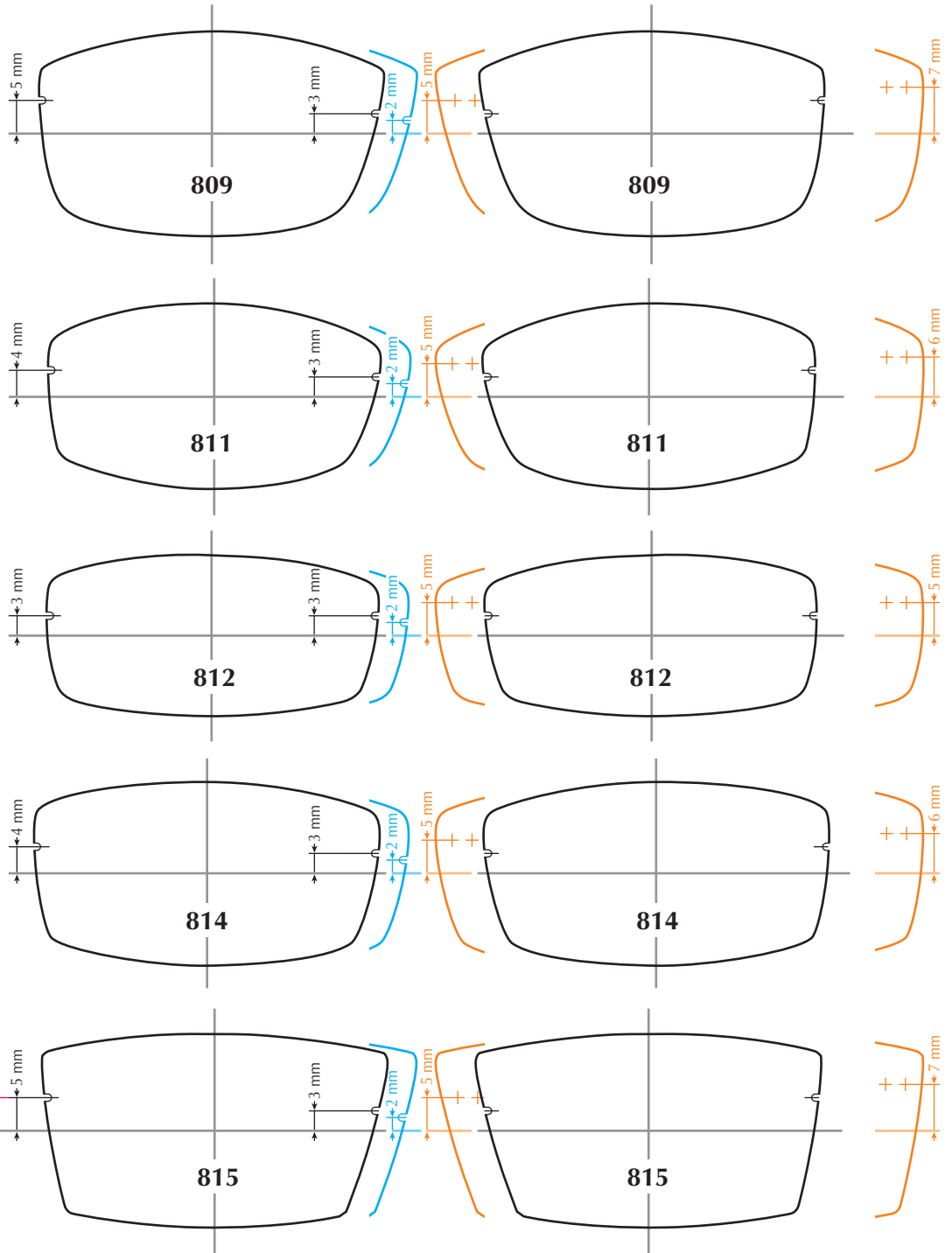

Toutes ces informations sont communiquées à titre indicatif et doivent être adaptées à la forme du nez du porteur.  
All infos provided must be adapted to shape and size of the patient's nose.

⚠ Attention : certaines imprimantes peuvent ne pas reproduire ce document à l'échelle exacte.  
Note: some printers may not duplicate this document at the correct scale.



M-22	M-21	M-503	M-0/OP/1/2/3/4/5	Pont traditionnel Traditional bridge	Pont W nu W bridge bare	Pont M-8 / M-5C M-8 / M-5C bridge	M-5C / M-8 / 57C 58C / 59C / 60C / 61C 62C / 63C / 64C / 81 501C / 502C
	M-25	M-505	7 / 52 / 53 / 56 / 57 58 / 59 / 60 / 61 / 62 63 / 64 / 71 / 501 / 502	Pont W avec selle clipsée W bridge with clipped saddle ou Pont P/P Bridge			

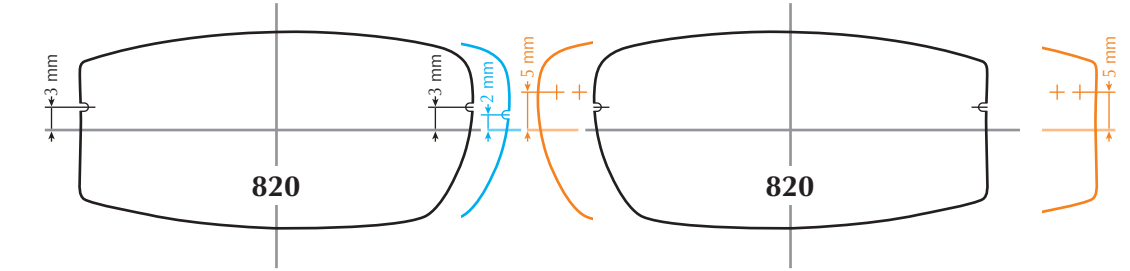
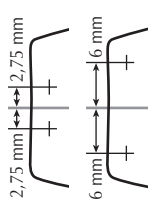
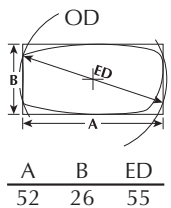
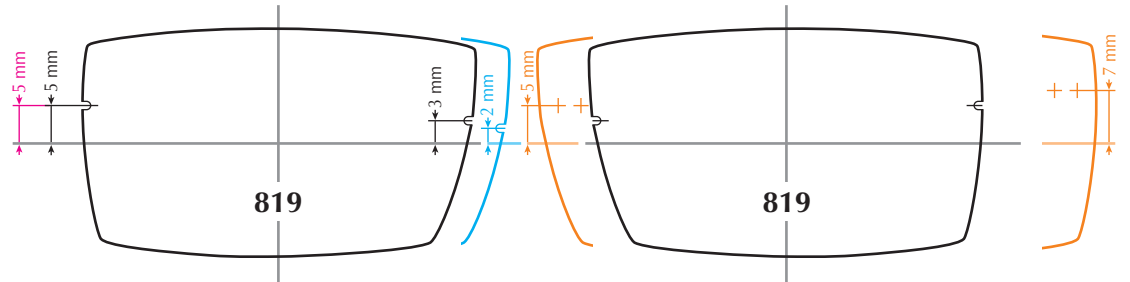
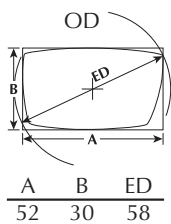
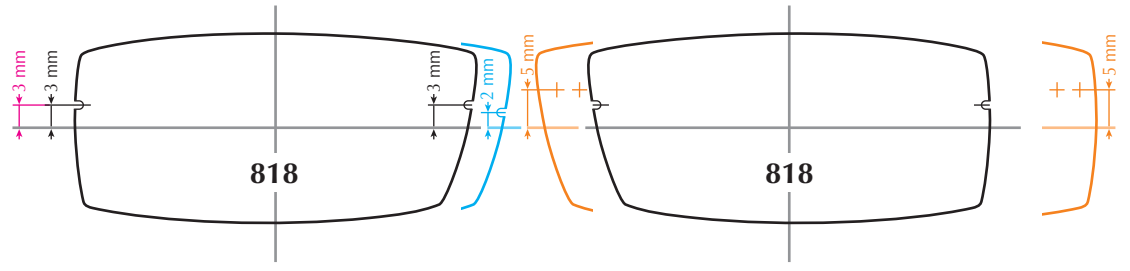
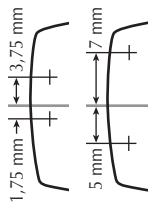
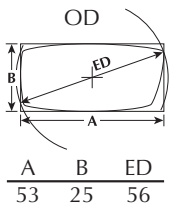
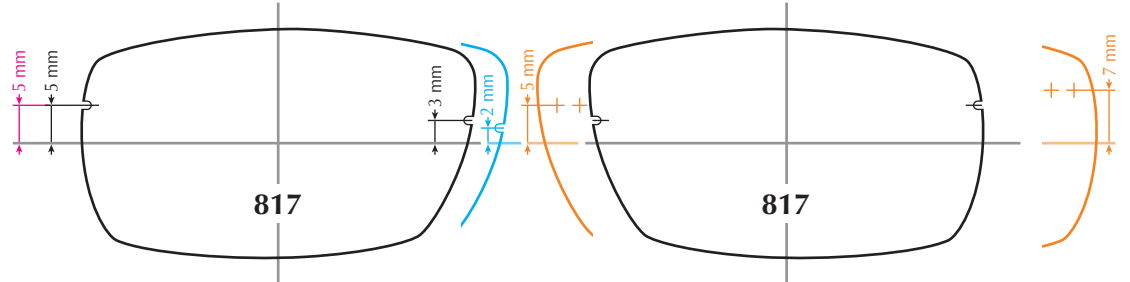
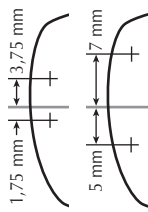
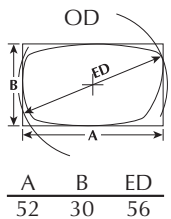
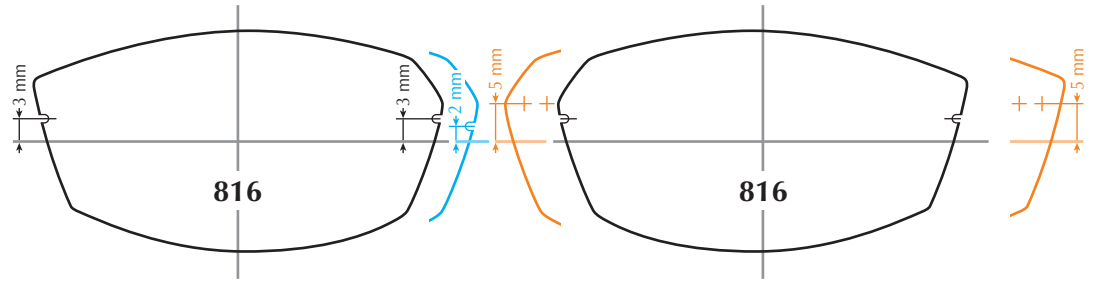
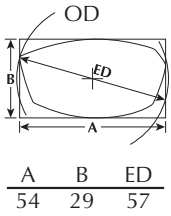

Toutes ces informations sont communiquées à titre indicatif et doivent être adaptées à la forme du nez du porteur.  
All infos provided must be adapted to shape and size of the patient's nose.

⚠ Attention : certaines imprimantes peuvent ne pas reproduire ce document à l'échelle exacte.  
Note: some printers may not duplicate this document at the correct scale.





M-22 M-21 M-503 M-0/OP/1/2/3/4/5 Pont traditionnel / Traditional bridge  
 M-25 M-505 7/52/53/56/57 Pont W avec selle clipsée / W bridge with clipped saddle  
 58/59/60/61/62 ou Pont P/P Bridge  
 Pont W nu / W bridge bare  
 Pont M-8 / M-5C / M-8 / M-5C bridge

M-5C / M-8 / 57C  
 58C / 59C / 60C / 61C  
 62C / 63C / 64C / 81  
 501C / 502C

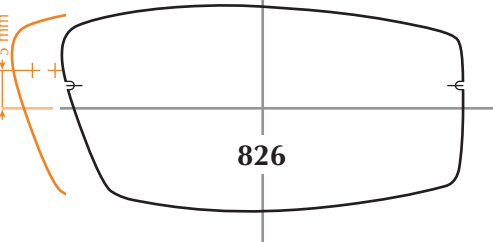
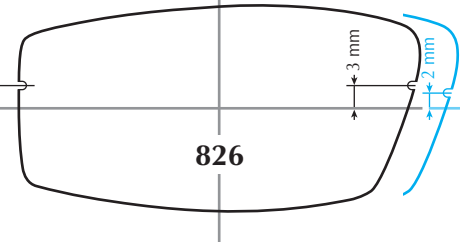
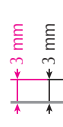
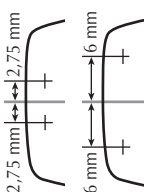
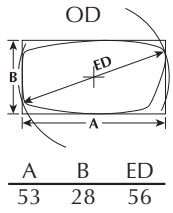
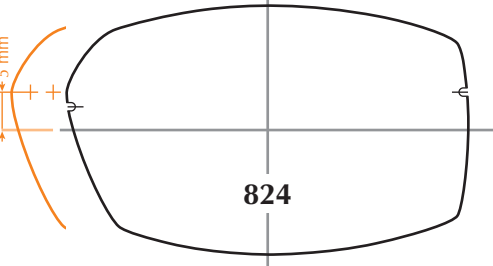
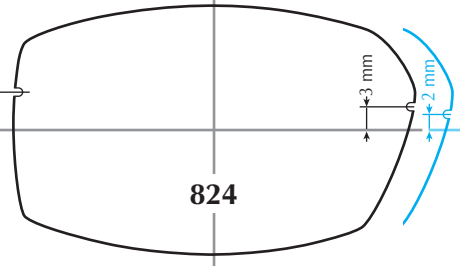
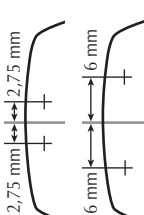
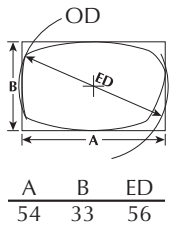
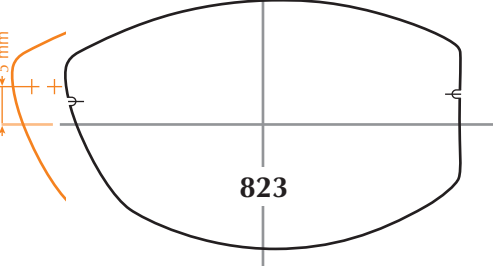
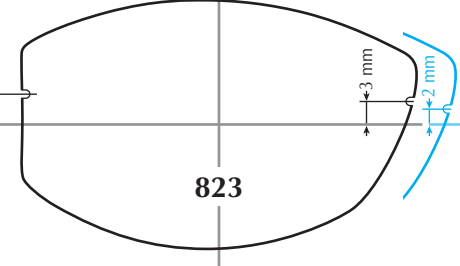
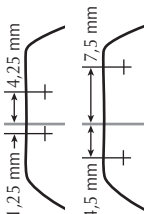
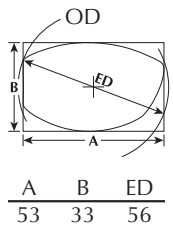
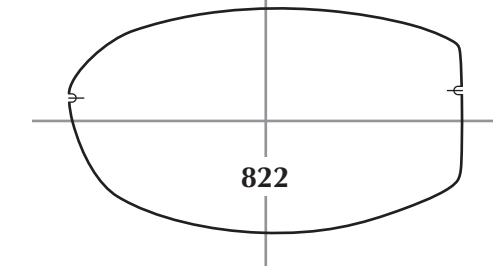
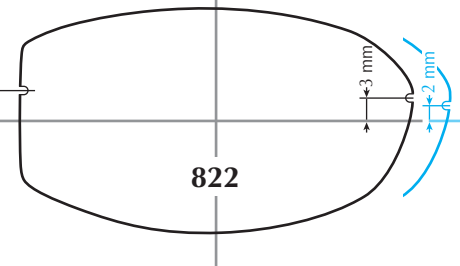
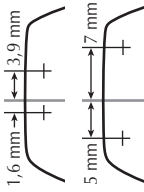
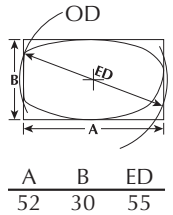
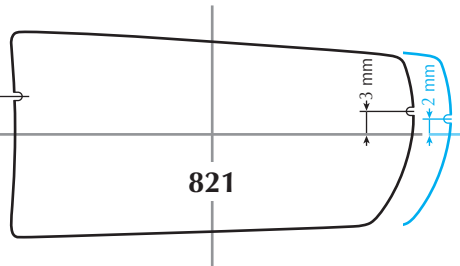
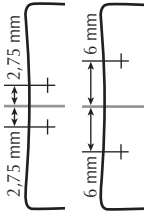
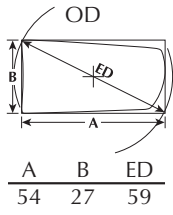

Toutes ces informations sont communiquées à titre indicatif et doivent être adaptées à la forme du nez du porteur.  
 All infos provided must be adapted to shape and size of the patient's nose.

Attention : certaines imprimantes peuvent ne pas reproduire ce document à l'échelle exacte.  
 Note: some printers may not duplicate this document at the correct scale.



M-22	M-21	M-503	M-0/OP/1/2/3/4/5	Pont traditionnel Traditional bridge	Pont W nu W bridge bare	Pont M-8 / M-5C M-8 / M-5C bridge	M-5C / M-8 / 57C 58C / 59C / 60C / 61C 62C / 63C / 64C / 81 501C / 502C
	M-25	M-505	7 / 52 / 53 / 56 / 57 58 / 59 / 60 / 61 / 62 63 / 64 / 71 / 501 / 502	Pont W avec selle clipsée W bridge with clipped saddle ou Pont P/P Bridge			

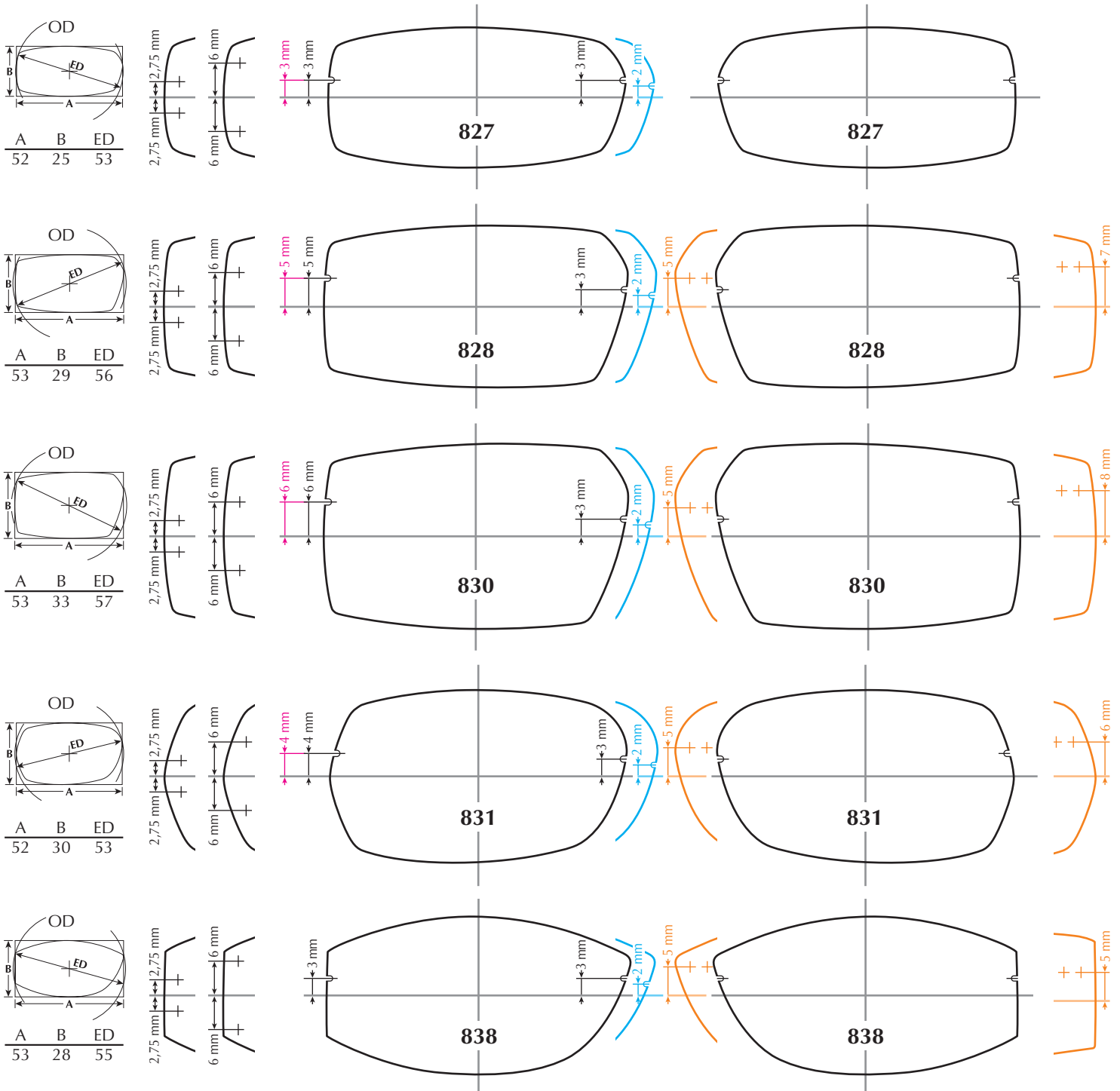

Toutes ces informations sont communiquées à titre indicatif et doivent être adaptées à la forme du nez du porteur.  
 All infos provided must be adapted to shape and size of the patient's nose.

⚠ Attention : certaines imprimantes peuvent ne pas reproduire ce document à l'échelle exacte.  
 Note: some printers may not duplicate this document at the correct scale.



M-22	M-21	M-503	M-0/OP/1/2/3/4/5	Pont traditionnel Traditional bridge	Pont W nu W bridge bare	Pont M-8 / M-5C M-8 / M-5C bridge	M-5C / M-8 / 57C 58C / 59C / 60C / 61C 62C / 63C / 64C / 81 501C / 502C
	M-25	M-505	7 / 52 / 53 / 56 / 57 58 / 59 / 60 / 61 / 62 63 / 64 / 71 / 501 / 502	Pont W avec selle clipsée W bridge with clipped saddle ou Pont P/P Bridge			

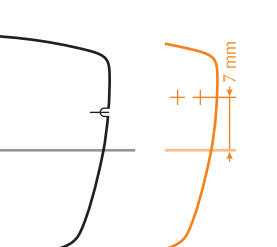
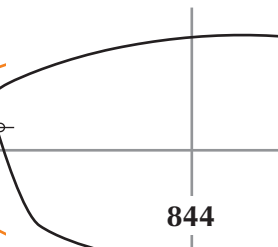
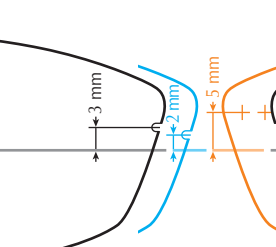
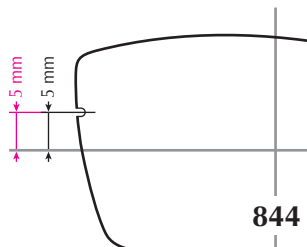
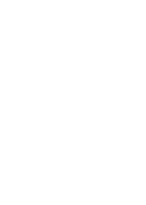
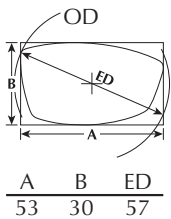
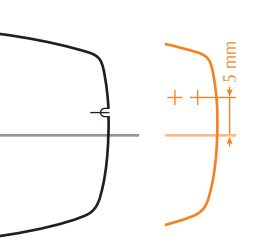
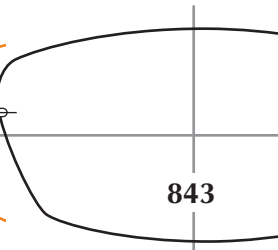
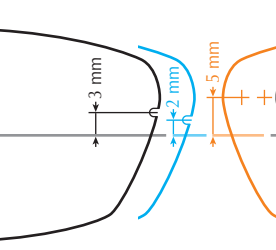
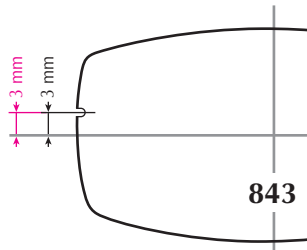
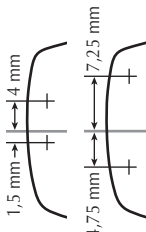
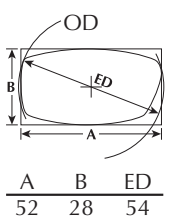
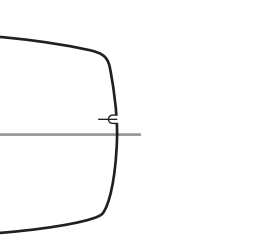
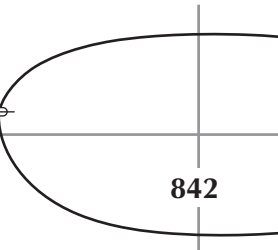
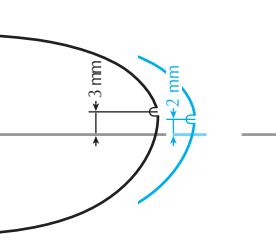
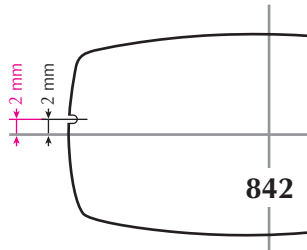
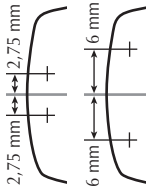
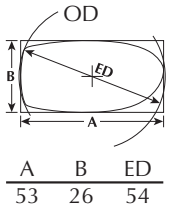
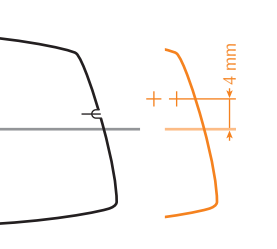
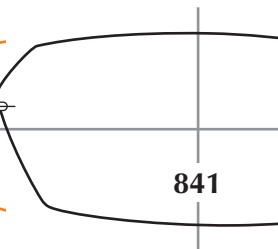
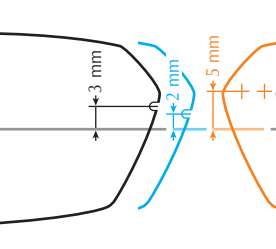
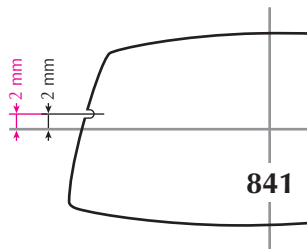
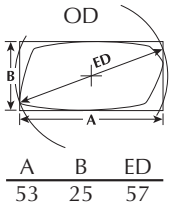
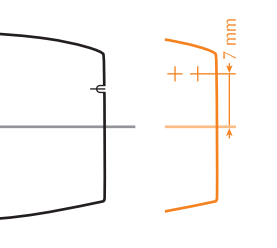
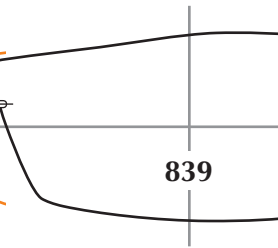
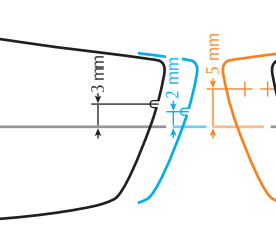
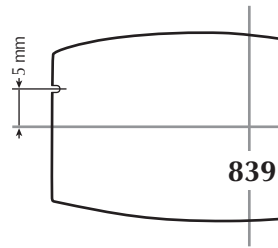
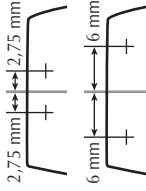
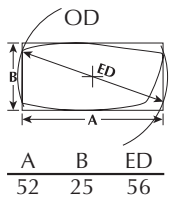

Toutes ces informations sont communiquées à titre indicatif et doivent être adaptées à la forme du nez du porteur.  
All infos provided must be adapted to shape and size of the patient's nose.

⚠ Attention : certaines imprimantes peuvent ne pas reproduire ce document à l'échelle exacte.  
Note: some printers may not duplicate this document at the correct scale.



M-22	M-21	M-503	M-0/OP/1/2/3/4/5	Pont traditionnel Traditional bridge	Pont W nu W bridge bare	Pont M-8 / M-5C M-8 / M-5C bridge	M-5C / M-8 / 57C 58C / 59C / 60C / 61C 62C / 63C / 64C / 81 501C / 502C
	M-25	M-505	7 / 52 / 53 / 56 / 57 58 / 59 / 60 / 61 / 62 63 / 64 / 71 / 501 / 502	Pont W avec selle clipsée W bridge with clipped saddle ou Pont P/P Bridge			

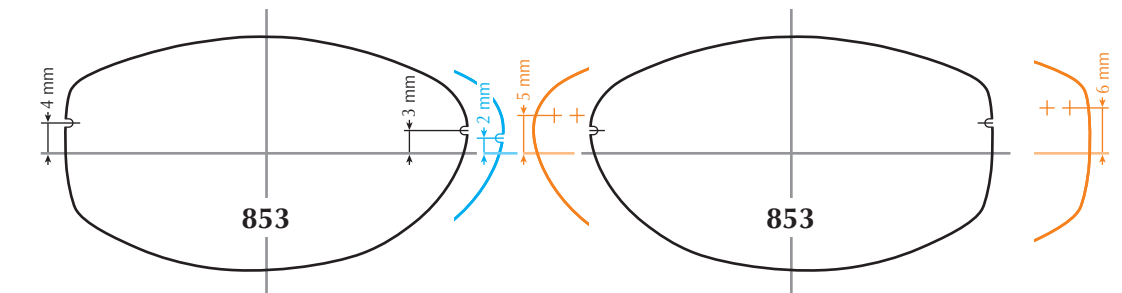
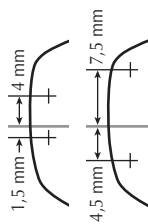
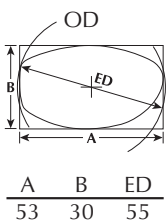
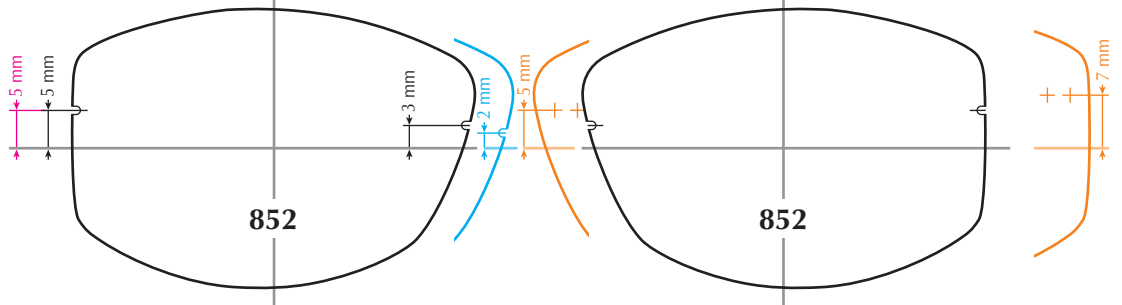
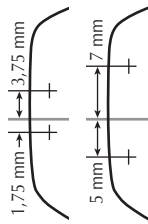
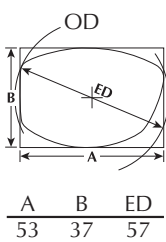
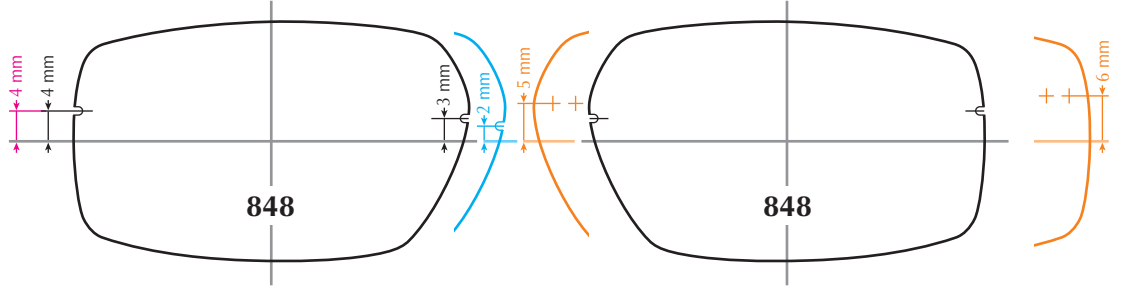
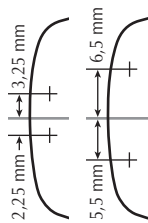
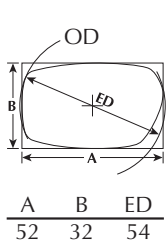
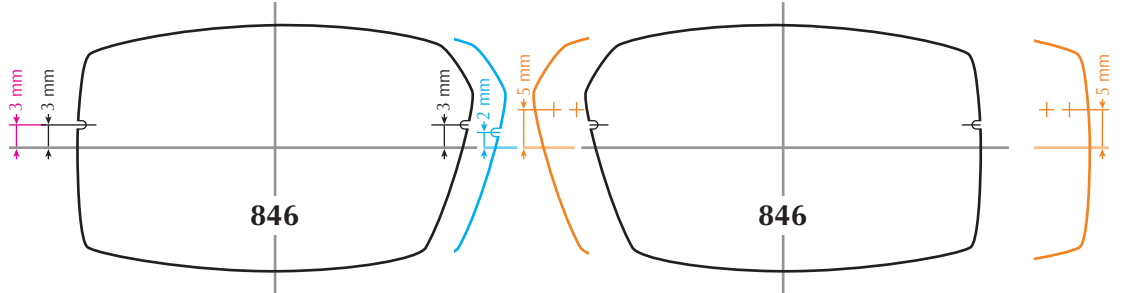
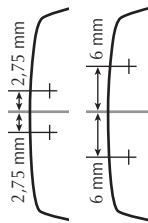
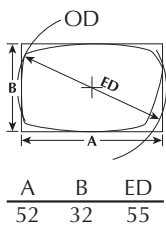
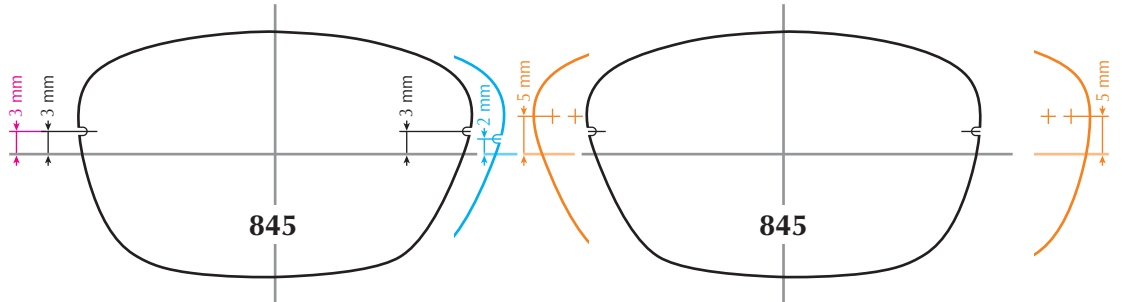
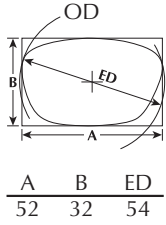

Toutes ces informations sont communiquées à titre indicatif et doivent être adaptées à la forme du nez du porteur.  
All infos provided must be adapted to shape and size of the patient's nose.

⚠ Attention : certaines imprimantes peuvent ne pas reproduire ce document à l'échelle exacte.  
Note: some printers may not duplicate this document at the correct scale.



M-22	M-21	M-503	M-0/OP/1/2/3/4/5	Pont traditionnel Traditional bridge	Pont W nu W bridge bare	Pont M-8 / M-5C M-8 / M-5C bridge	M-5C / M-8 / 57C 58C / 59C / 60C / 61C 62C / 63C / 64C / 81 501C / 502C
	M-25	M-505	7 / 52 / 53 / 56 / 57 58 / 59 / 60 / 61 / 62 63 / 64 / 71 / 501 / 502	Pont W avec selle clipsée W bridge with clipped saddle ou Pont P/P Bridge			

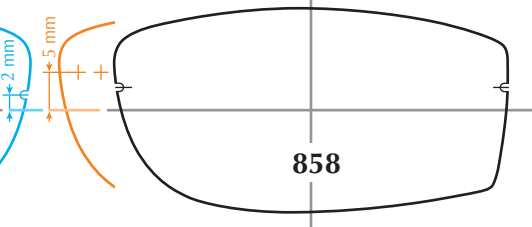
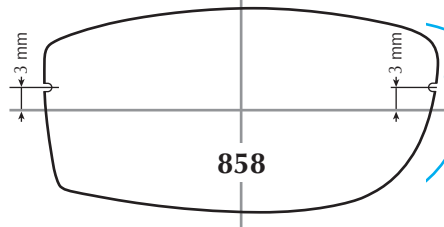
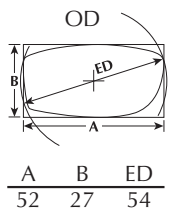
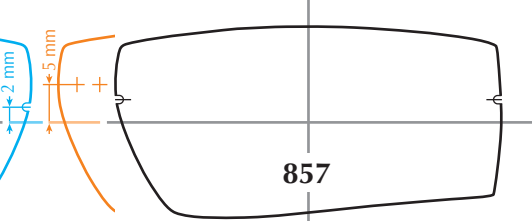
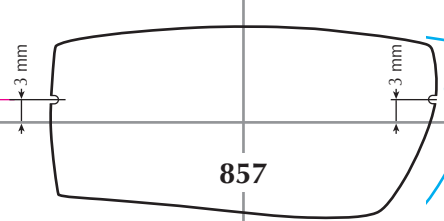
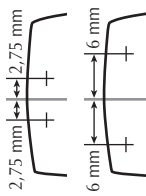
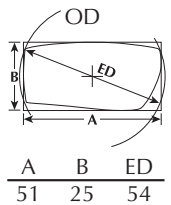
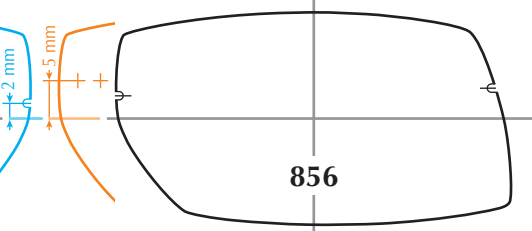
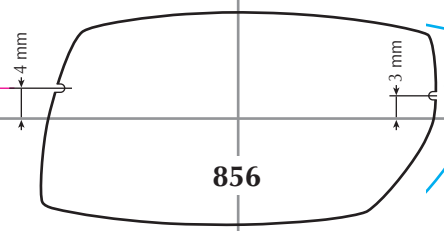
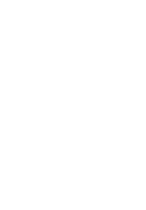
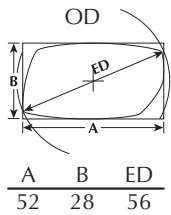
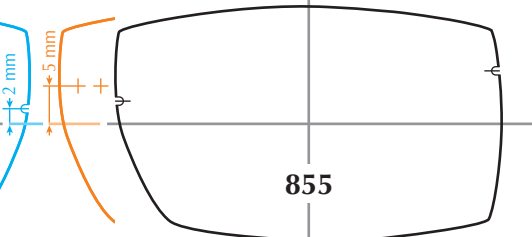
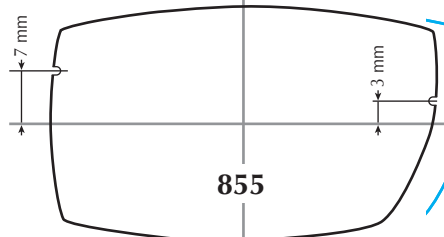
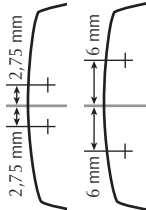
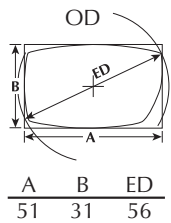
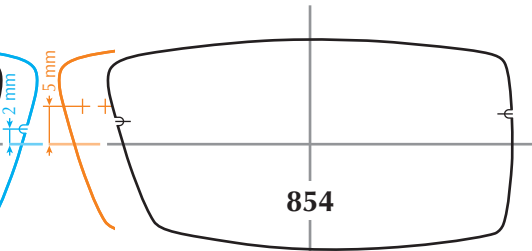
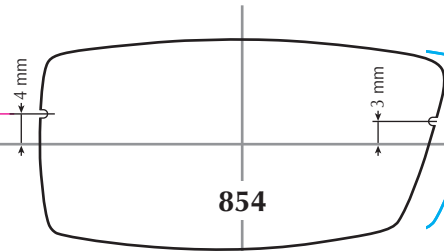
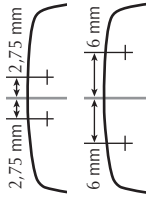
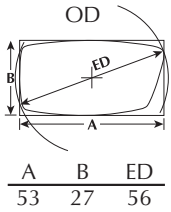

Toutes ces informations sont communiquées à titre indicatif et doivent être adaptées à la forme du nez du porteur.  
All infos provided must be adapted to shape and size of the patient's nose.

⚠ Attention : certaines imprimantes peuvent ne pas reproduire ce document à l'échelle exacte.  
Note: some printers may not duplicate this document at the correct scale.

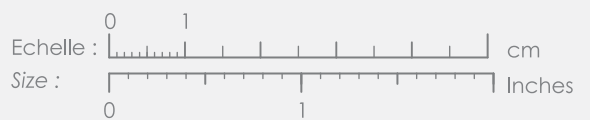

M-22	M-21	M-503	M-0/OP/1/2/3/4/5	Pont traditionnel Traditional bridge	Pont W nu W bridge bare	Pont M-8 / M-5C M-8 / M-5C bridge	M-5C / M-8 / 57C 58C / 59C / 60C / 61C 62C / 63C / 64C / 81 501C / 502C
	M-25	M-505	7 / 52 / 53 / 56 / 57 58 / 59 / 60 / 61 / 62 63 / 64 / 71 / 501 / 502	Pont W avec selle clipsée W bridge with clipped saddle ou Pont P/P Bridge			

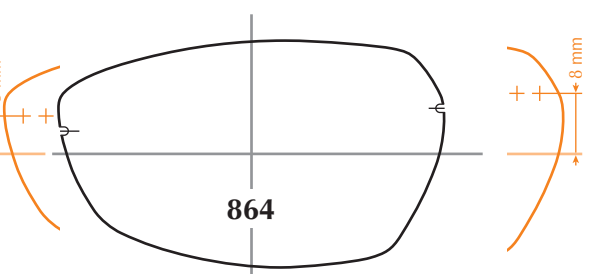
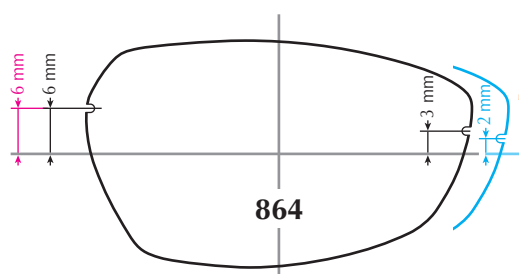
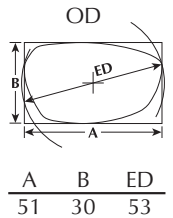
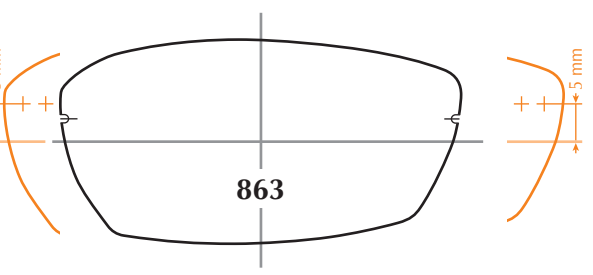
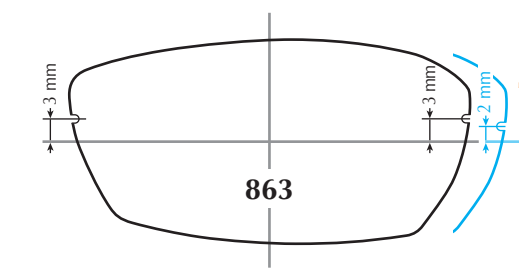
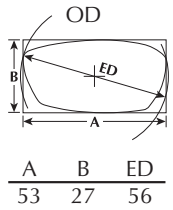
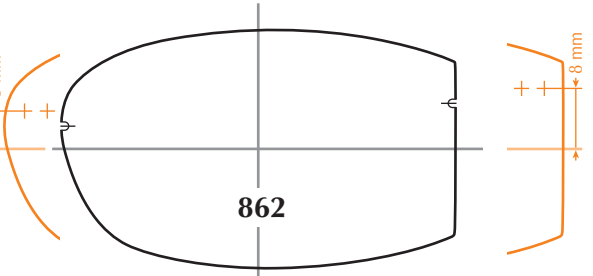
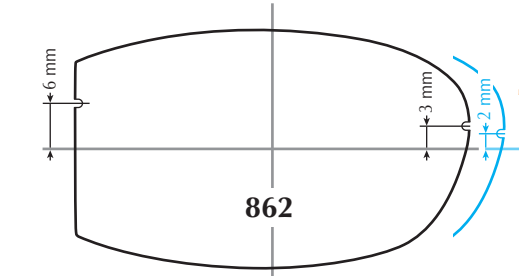
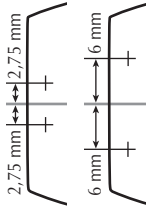
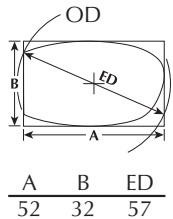
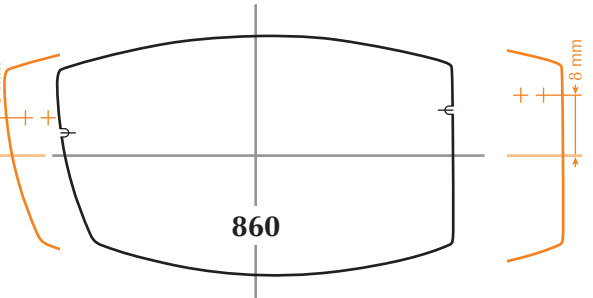
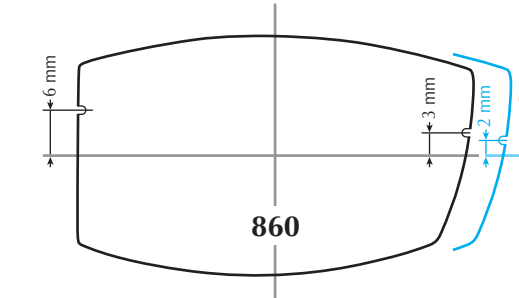
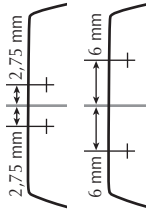
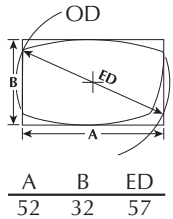
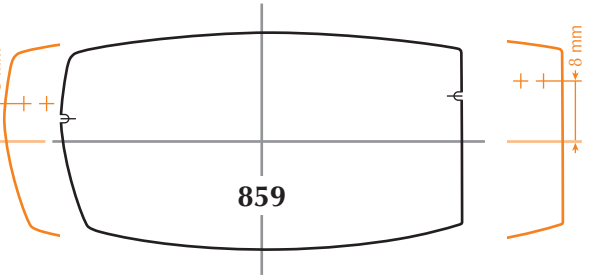
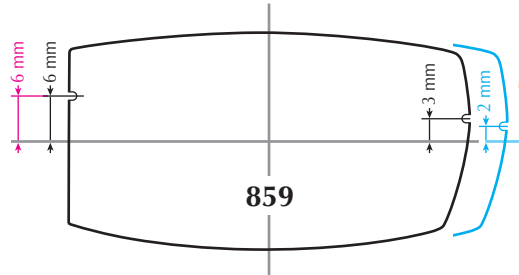
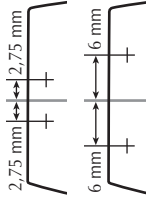
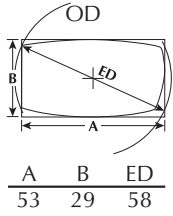

Toutes ces informations sont communiquées à titre indicatif et doivent être adaptées à la forme du nez du porteur.  
All infos provided must be adapted to shape and size of the patient's nose.

⚠ Attention : certaines imprimantes peuvent ne pas reproduire ce document à l'échelle exacte.  
Note: some printers may not duplicate this document at the correct scale.



M-22 M-21 M-503  
M-25 M-505

M-0 / OP / 1 / 2 / 3 / 4 / 5  
7 / 52 / 53 / 56 / 57  
58 / 59 / 60 / 61 / 62  
63 / 64 / 71 / 501 / 502

Pont traditionnel  
Traditional bridge  
Pont W avec selle clipsée  
W bridge with clipped saddle  
ou Pont P/P Bridge

Pont W nu  
W bridge bare

Pont M-8 / M-5C  
M-8 / M-5C bridge

M-5C / M-8 / 57C  
58C / 59C / 60C / 61C  
62C / 63C / 64C / 81  
501C / 502C

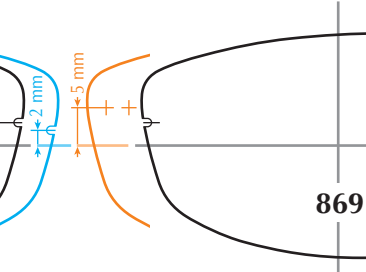
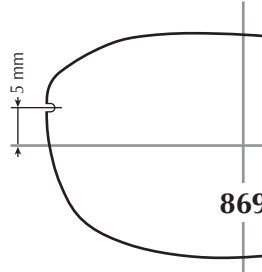
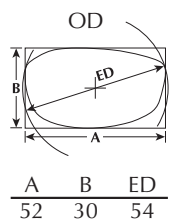
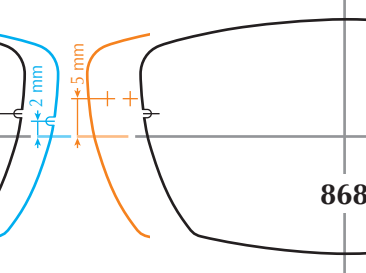
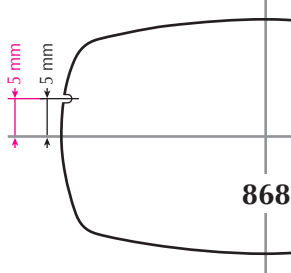
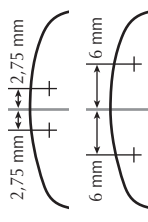
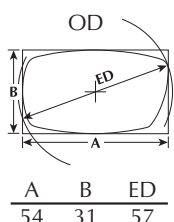
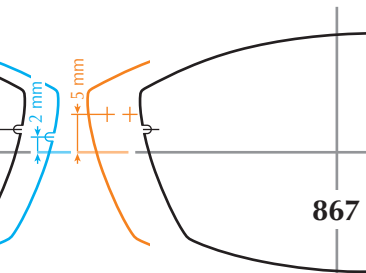
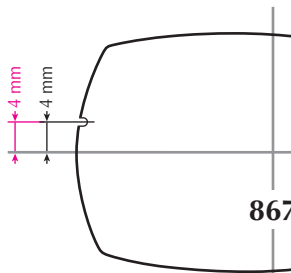
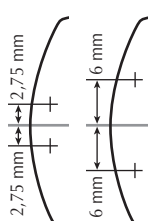
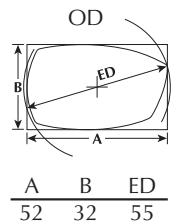
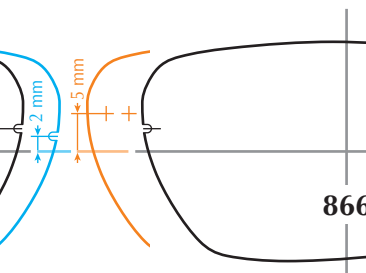
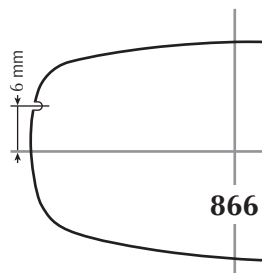
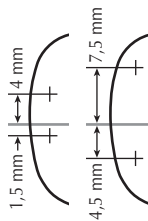
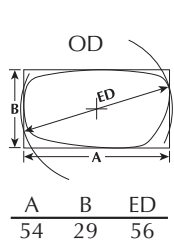
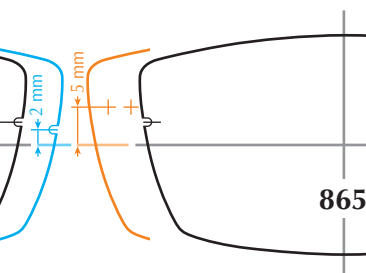
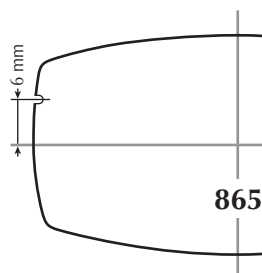
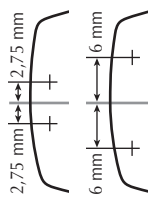
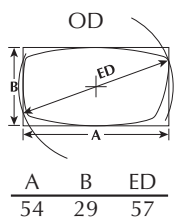

Toutes ces informations sont communiquées à titre indicatif et doivent être adaptées à la forme du nez du porteur.  
All infos provided must be adapted to shape and size of the patient's nose.

⚠ Attention : certaines imprimantes peuvent ne pas reproduire ce document à l'échelle exacte.  
Note: some printers may not duplicate this document at the correct scale.

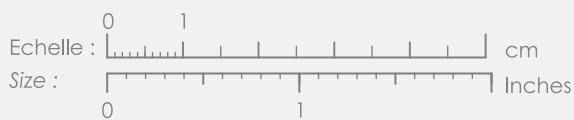

M-22	M-21	M-503	M-0/OP/1/2/3/4/5	Pont traditionnel Traditional bridge	Pont W nu W bridge bare	Pont M-8 / M-5C M-8 / M-5C bridge	M-5C / M-8 / 57C 58C / 59C / 60C / 61C 62C / 63C / 64C / 81 501C / 502C
	M-25	M-505	7 / 52 / 53 / 56 / 57 58 / 59 / 60 / 61 / 62 63 / 64 / 71 / 501 / 502	Pont W avec selle clipsée W bridge with clipped saddle ou Pont P/P Bridge			

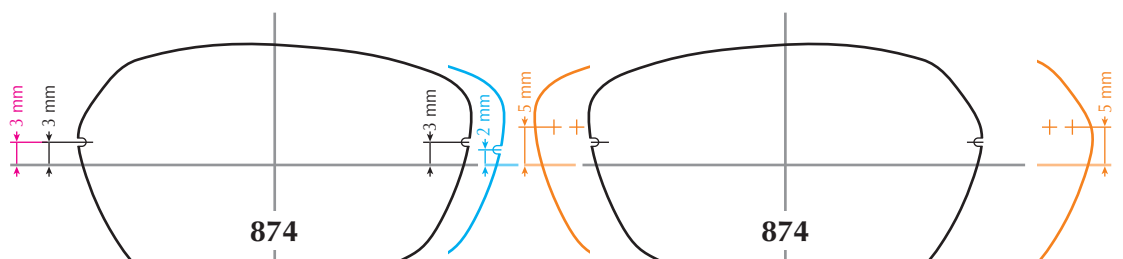
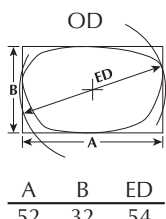
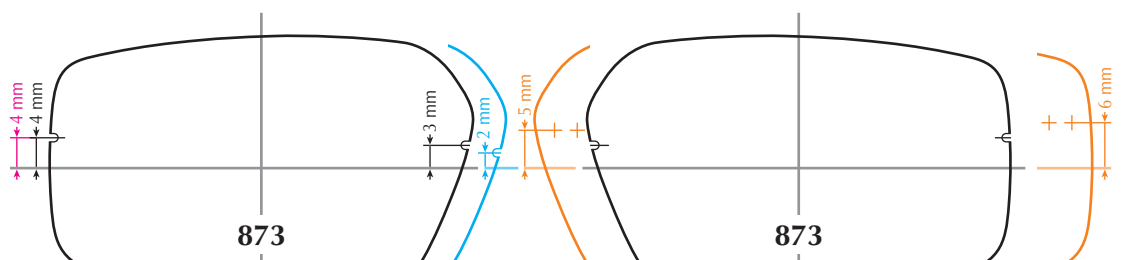
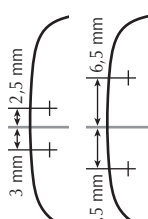
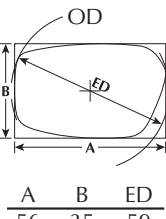
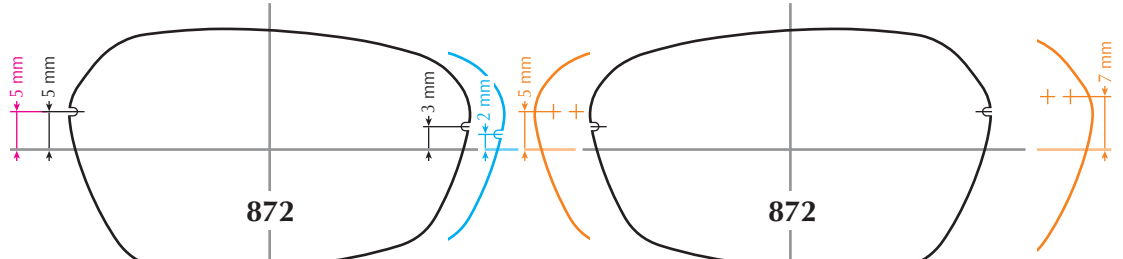
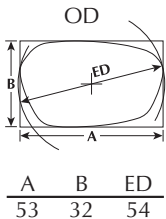
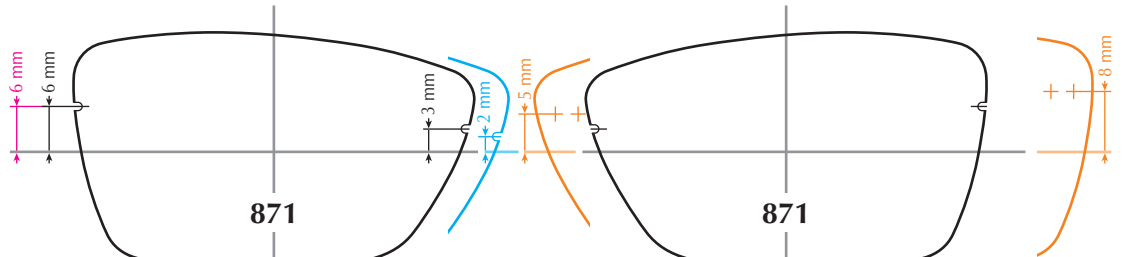
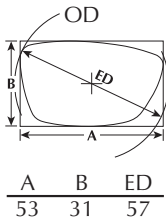
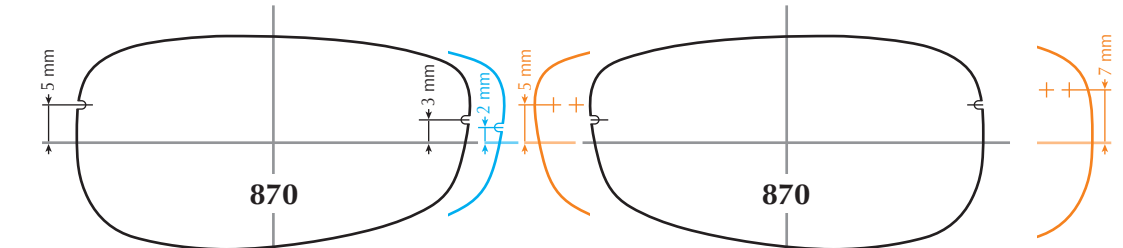
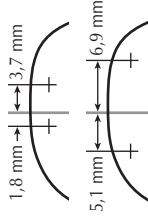
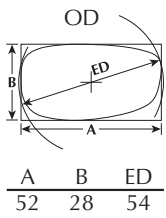

Toutes ces informations sont communiquées à titre indicatif et doivent être adaptées à la forme du nez du porteur.  
All infos provided must be adapted to shape and size of the patient's nose.

⚠ Attention : certaines imprimantes peuvent ne pas reproduire ce document à l'échelle exacte.  
Note: some printers may not duplicate this document at the correct scale.





M-22	M-21	M-503	M-0/OP/1/2/3/4/5	Pont traditionnel Traditional bridge	Pont W nu W bridge bare	Pont M-8 / M-5C M-8 / M-5C bridge	M-5C / M-8 / 57C 58C / 59C / 60C / 61C 62C / 63C / 64C / 81 501C / 502C
	M-25	M-505	7 / 52 / 53 / 56 / 57 58 / 59 / 60 / 61 / 62 63 / 64 / 71 / 501 / 502	Pont W avec selle clipsée W bridge with clipped saddle ou Pont P/P Bridge			

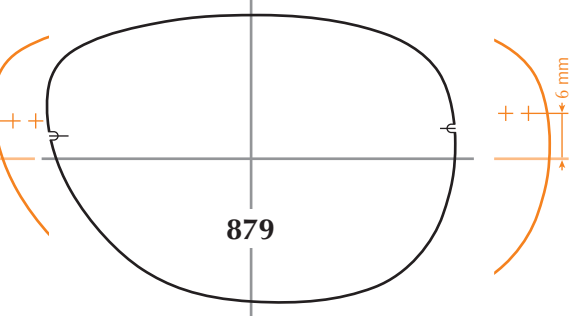
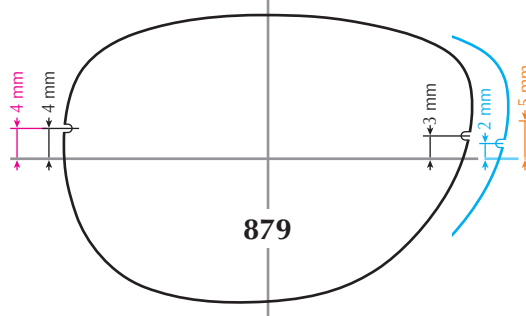
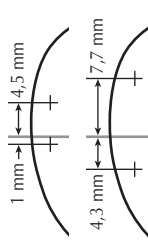
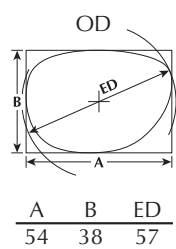
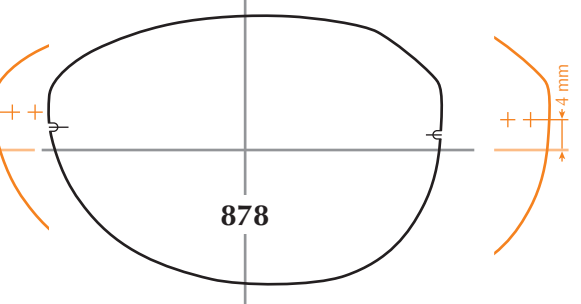
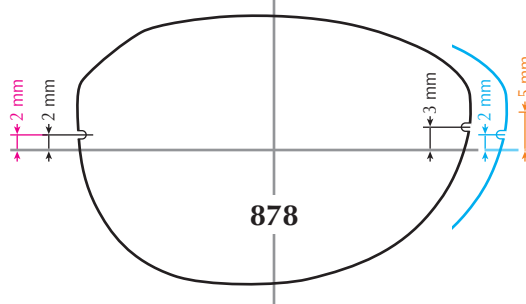
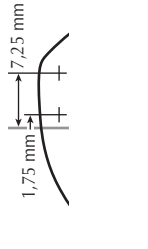
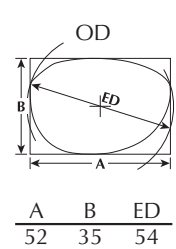
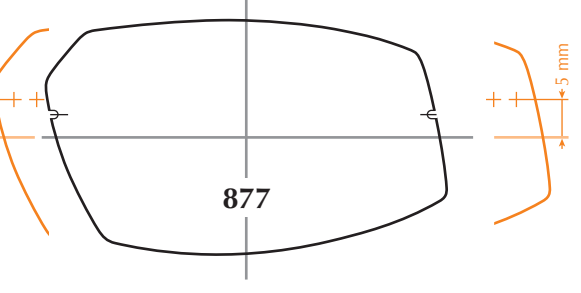
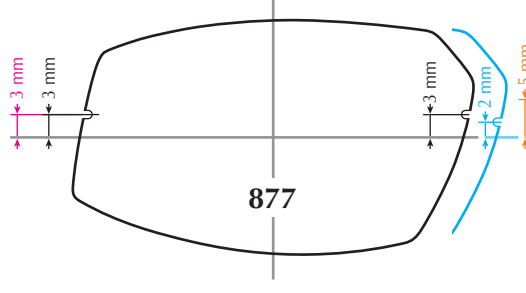
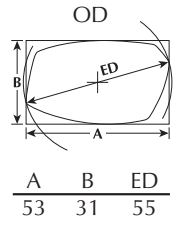
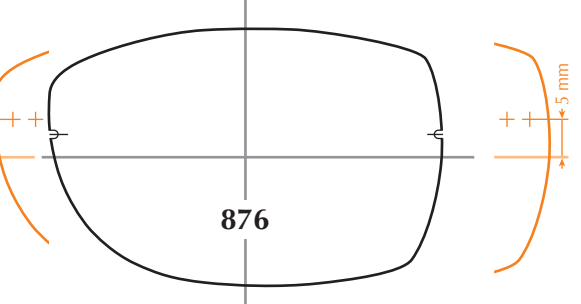
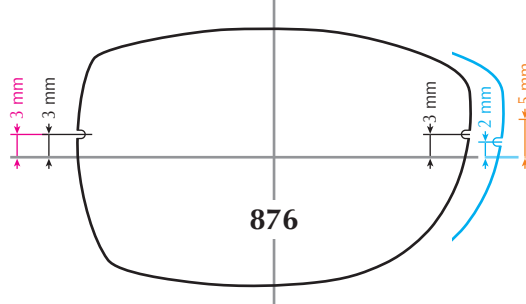
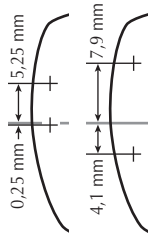
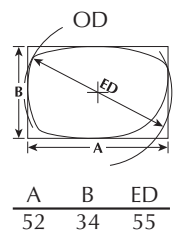
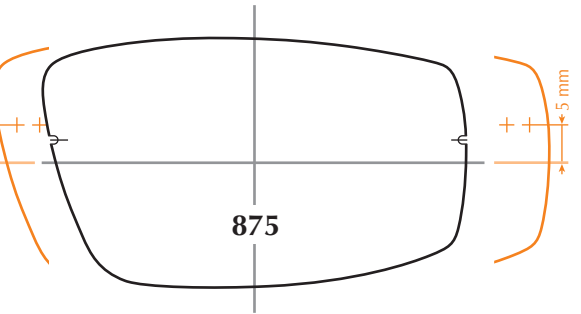
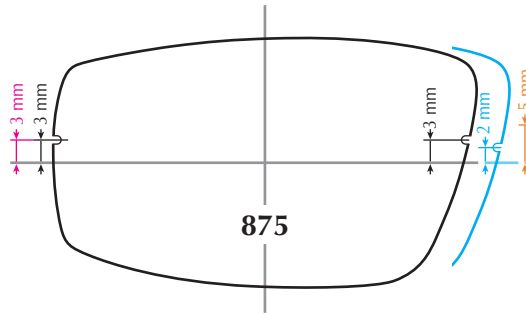
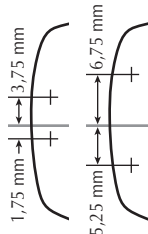
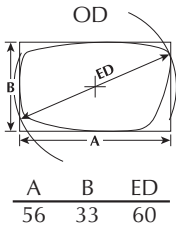

Toutes ces informations sont communiquées à titre indicatif et doivent être adaptées à la forme du nez du porteur.  
All infos provided must be adapted to shape and size of the patient's nose.

⚠ Attention : certaines imprimantes peuvent ne pas reproduire ce document à l'échelle exacte.  
Note: some printers may not duplicate this document at the correct scale.



M-22 M-21 M-503 M-0/0P/1/2/3/4/5 Pont traditionnel / Traditional bridge  
 M-25 M-505 7/52/53/56/57 Pont W avec selle clipsée / W bridge with clipped saddle  
 58/59/60/61/62 ou Pont P/P Bridge  
 Pont W nu / W bridge bare  
 Pont M-8 / M-5C / M-8 / M-5C bridge  
 M-5C / M-8 / 57C / 58C / 59C / 60C / 61C / 62C / 63C / 64C / 81 / 501C / 502C

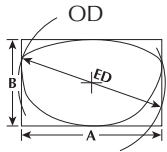

A B ED  
52 32 55

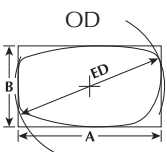
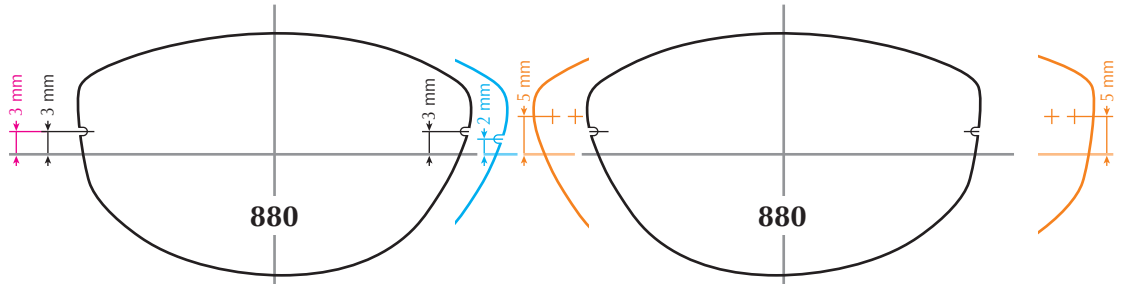

A B ED  
53 30 55

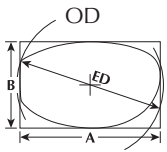
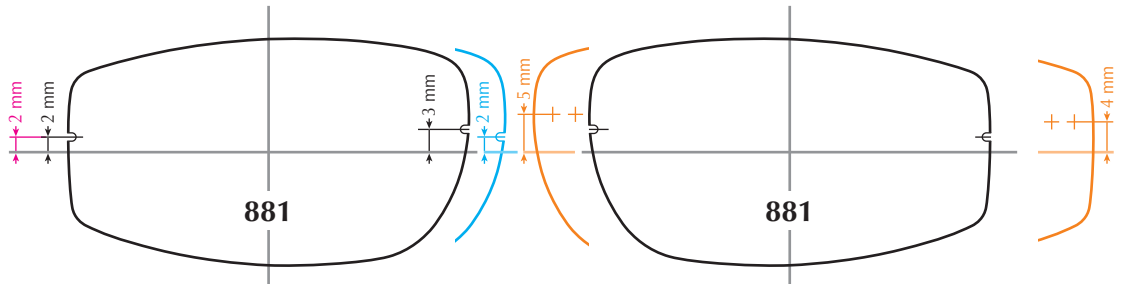
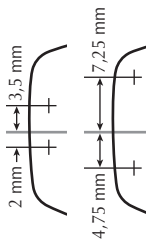

A B ED  
52 32 54

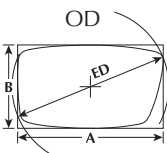
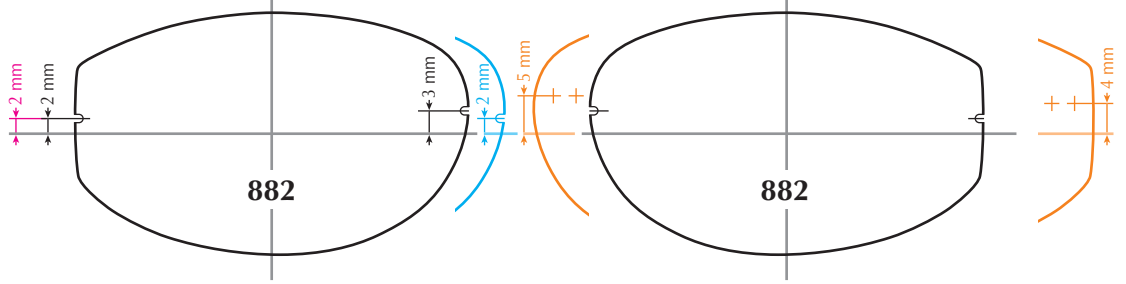
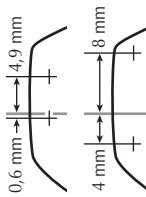

A B ED  
54 31 59

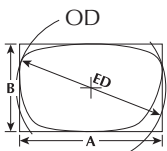
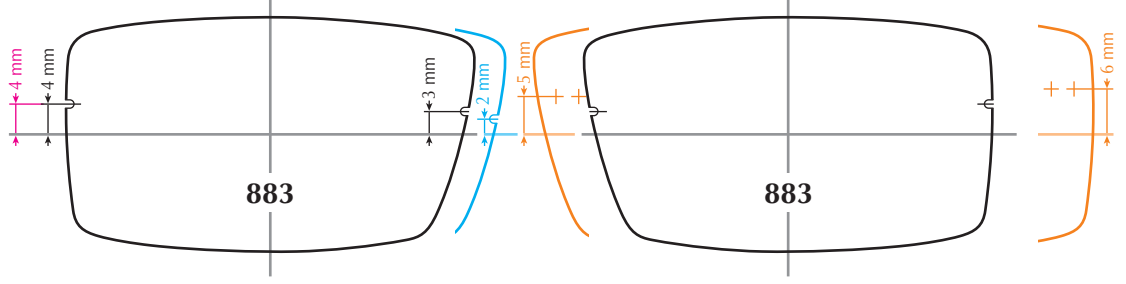
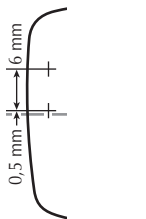

A B ED  
53 32,5 56

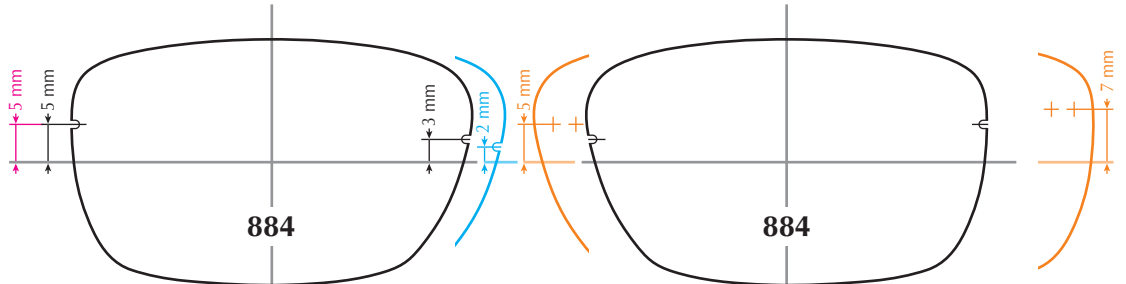

Toutes ces informations sont communiquées à titre indicatif et doivent être adaptées à la forme du nez du porteur.  
 All infos provided must be adapted to shape and size of the patient's nose.

⚠ Attention : certaines imprimantes peuvent ne pas reproduire ce document à l'échelle exacte.  
 Note: some printers may not duplicate this document at the correct scale.



M-22	M-21	M-503	M-0 / OP / 1 / 2 / 3 / 4 / 5	Pont traditionnel Traditional bridge	Pont W nu W bridge bare	Pont M-8 / M-5C M-8 / M-5C bridge	M-5C / M-8 / 57C 58C / 59C / 60C / 61C 62C / 63C / 64C / 81 501C / 502C
M-25	M-505		7 / 52 / 53 / 56 / 57 58 / 59 / 60 / 61 / 62 63 / 64 / 71 / 501 / 502	Pont W avec selle clipsée W bridge with clipped saddle ou Pont P/P Bridge			

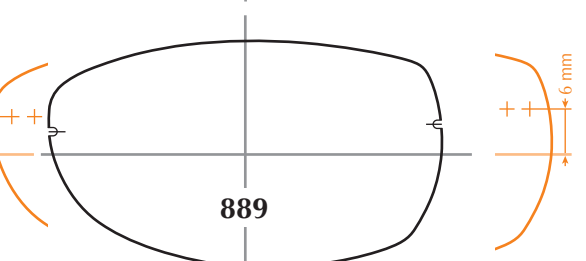
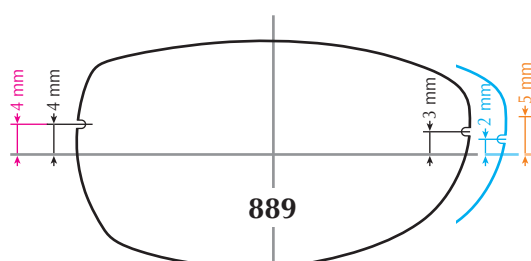
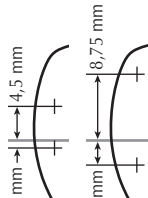
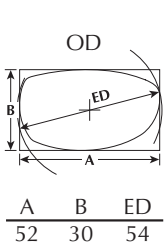
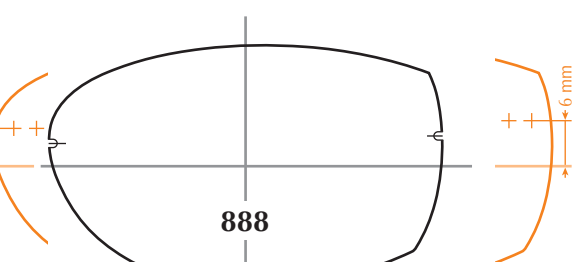
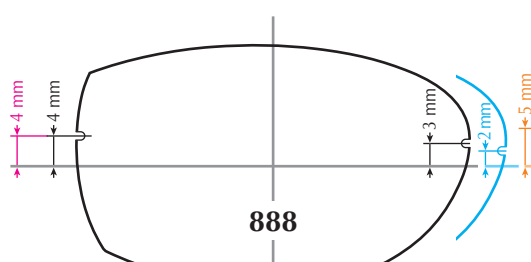
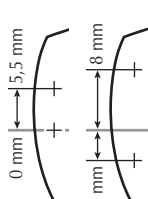
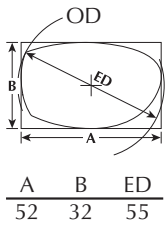
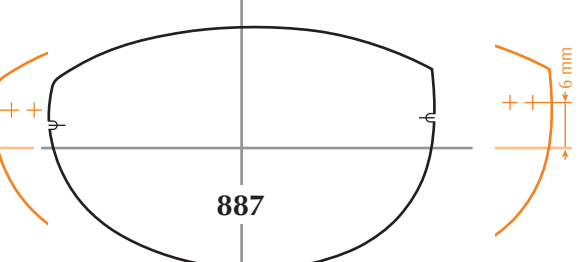
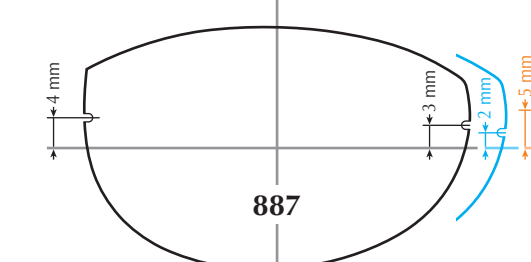
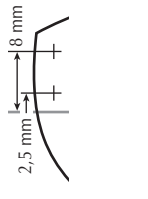
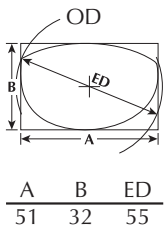
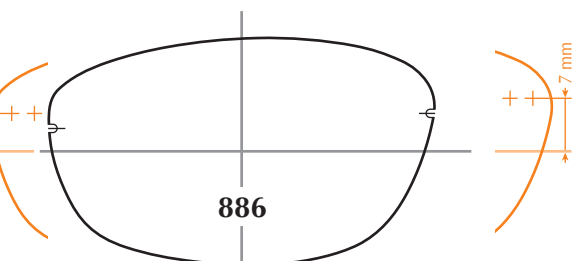
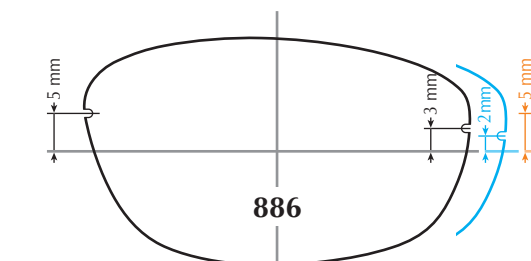
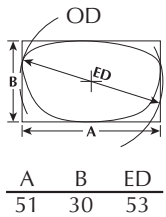
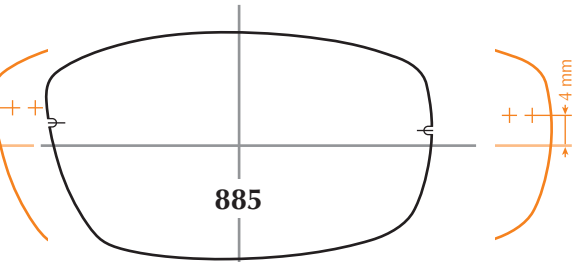
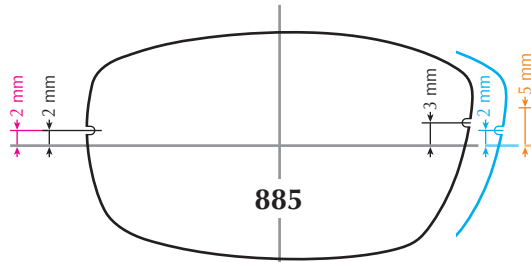
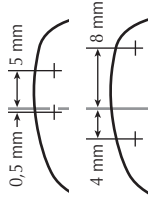
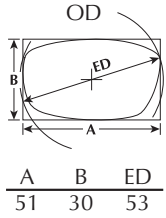

Toutes ces informations sont communiquées à titre indicatif et doivent être adaptées à la forme du nez du porteur.  
All infos provided must be adapted to shape and size of the patient's nose.

⚠ Attention : certaines imprimantes peuvent ne pas reproduire ce document à l'échelle exacte.  
Note: some printers may not duplicate this document at the correct scale.



M-22 M-21 M-503 M-0/OP/1/2/3/4/5 Pont traditionnel / Traditional bridge  
 M-25 M-505 7/52/53/56/57 Pont W avec selle clipsée / W bridge with clipped saddle  
 58/59/60/61/62 ou Pont P/P Bridge

Pont W nu / W bridge bare

Pont M-8 / M-5C / M-8 / M-5C bridge

M-5C / M-8 / 57C / 58C / 59C / 60C / 61C / 62C / 63C / 64C / 81 / 501C / 502C

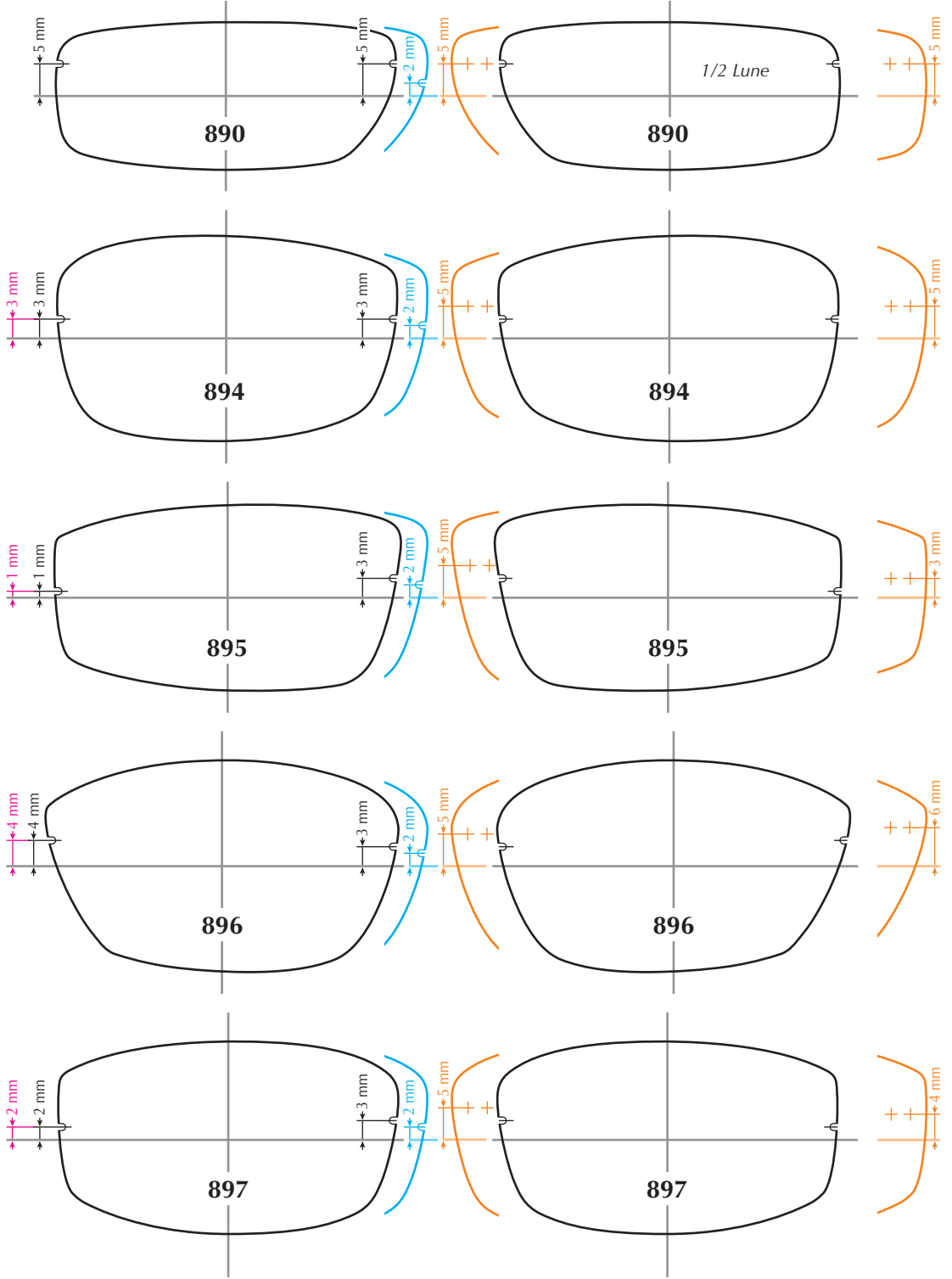
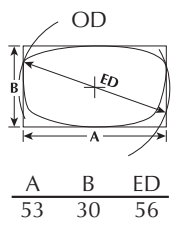
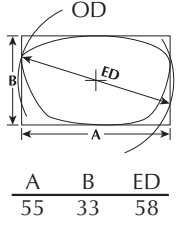
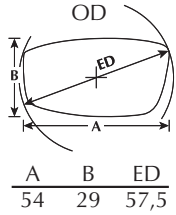
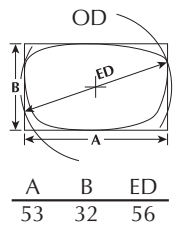
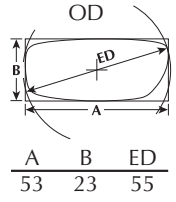

Toutes ces informations sont communiquées à titre indicatif et doivent être adaptées à la forme du nez du porteur.  
 All infos provided must be adapted to shape and size of the patient's nose.

⚠ Attention : certaines imprimantes peuvent ne pas reproduire ce document à l'échelle exacte.  
 Note: some printers may not duplicate this document at the correct scale.



M-22	M-21	M-503	M-0 / OP / 1 / 2 / 3 / 4 / 5	Pont traditionnel Traditional bridge	Pont W nu W bridge bare	Pont M-8 / M-5C M-8 / M-5C bridge	M-5C / M-8 / 57C 58C / 59C / 60C / 61C 62C / 63C / 64C / 81 501C / 502C
M-25	M-505	7 / 52 / 53 / 56 / 57 58 / 59 / 60 / 61 / 62 63 / 64 / 71 / 501 / 502	Pont W avec selle clipsée W bridge with clipped saddle ou Pont P/P Bridge				

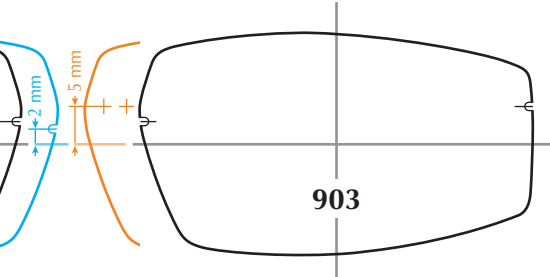
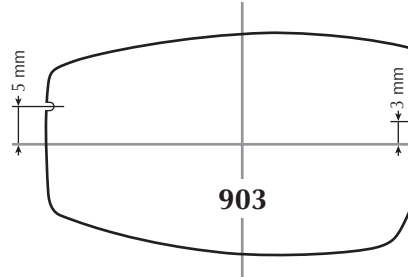
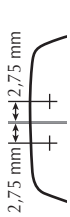
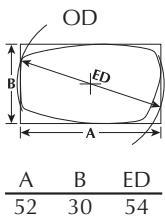
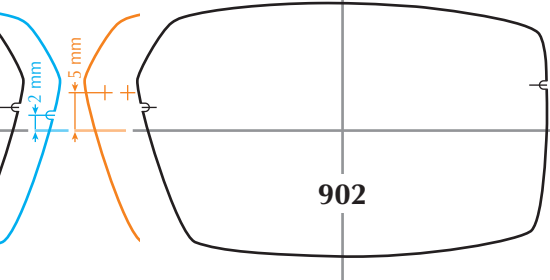
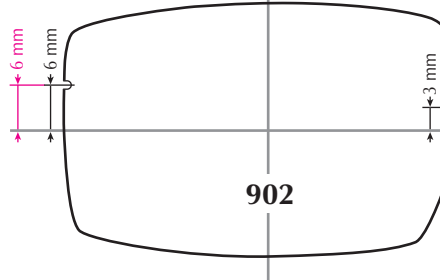
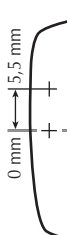
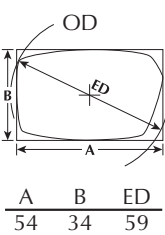
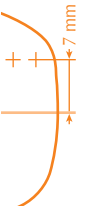
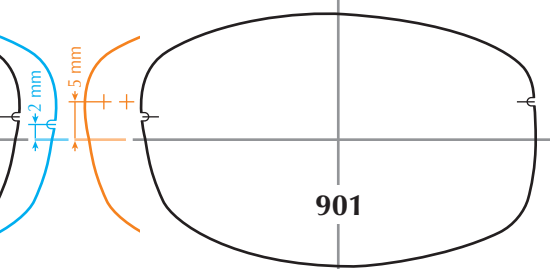
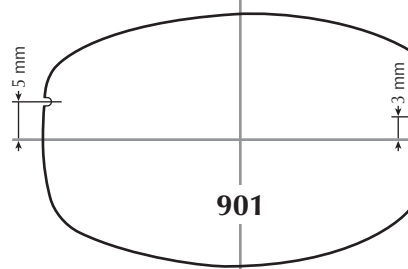
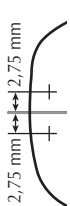
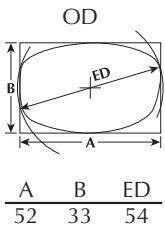
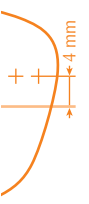
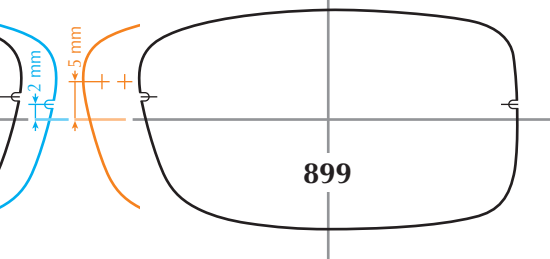
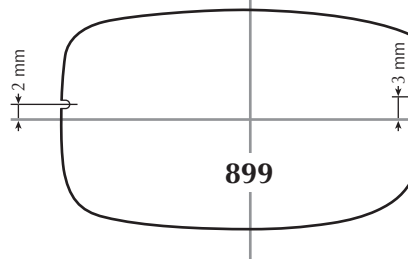
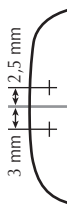
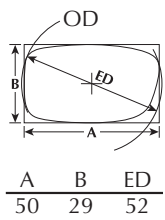
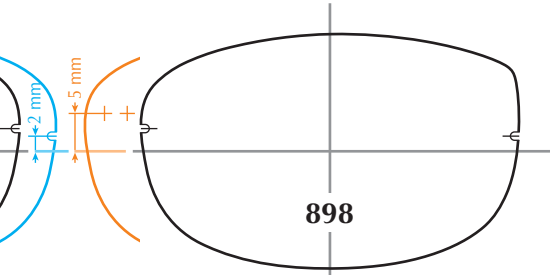
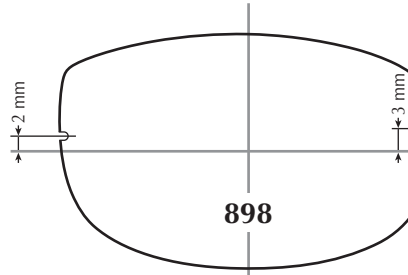
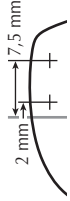
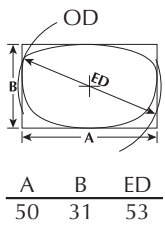

Toutes ces informations sont communiquées à titre indicatif et doivent être adaptées à la forme du nez du porteur.  
All infos provided must be adapted to shape and size of the patient's nose.

⚠ Attention : certaines imprimantes peuvent ne pas reproduire ce document à l'échelle exacte.  
Note: some printers may not duplicate this document at the correct scale.



M-22	M-21	M-503	M-0/OP/1/2/3/4/5	Pont traditionnel Traditional bridge	Pont W nu W bridge bare	Pont M-8 / M-5C M-8 / M-5C bridge	M-5C / M-8 / 57C 58C / 59C / 60C / 61C 62C / 63C / 64C / 81 501C / 502C
M-25	M-505		7 / 52 / 53 / 56 / 57 58 / 59 / 60 / 61 / 62 63 / 64 / 71 / 501 / 502	Pont W avec selle clipsée W bridge with clipped saddle ou Pont P/P Bridge			

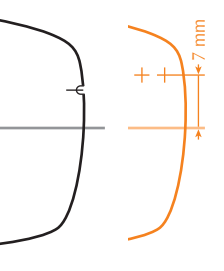
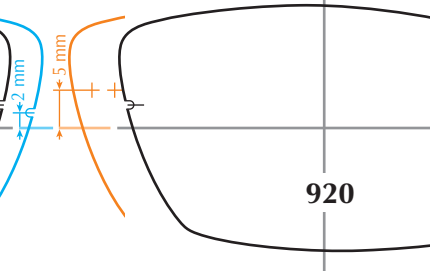
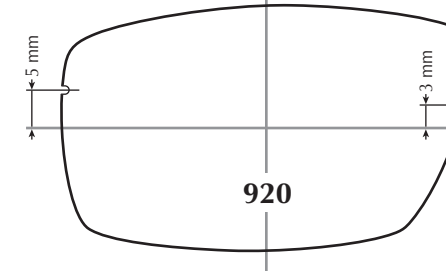
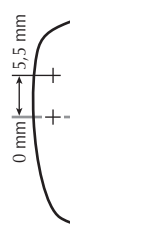
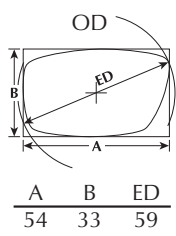
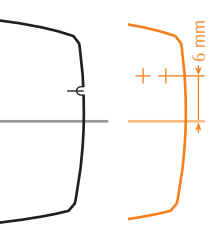
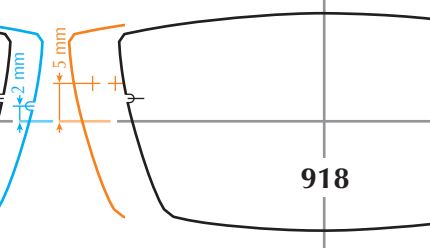
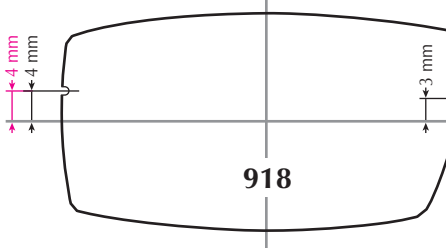
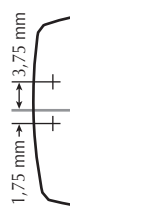
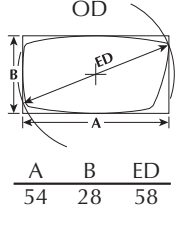
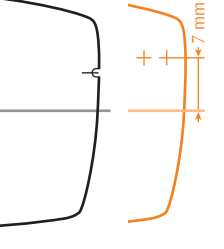
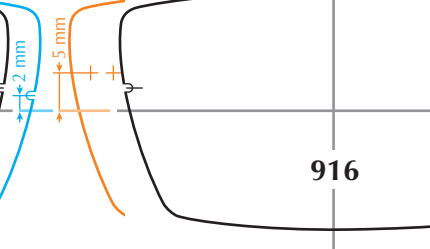
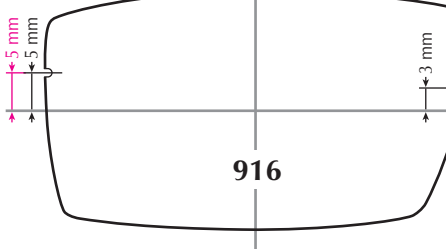
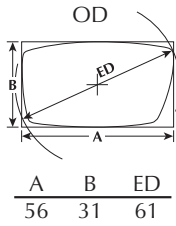
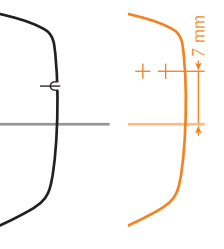
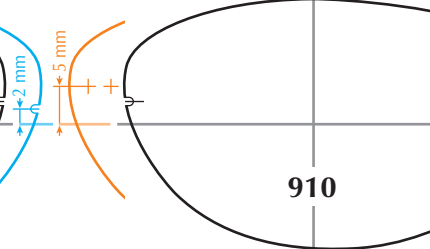
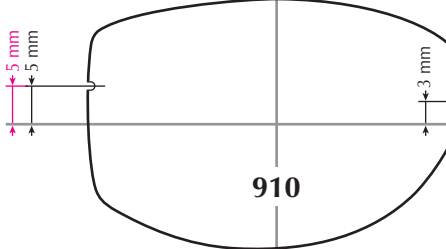
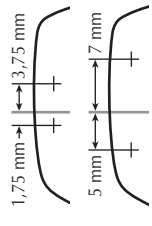
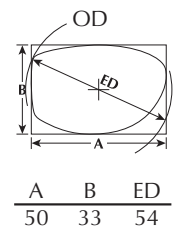
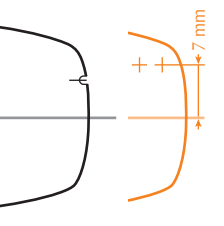
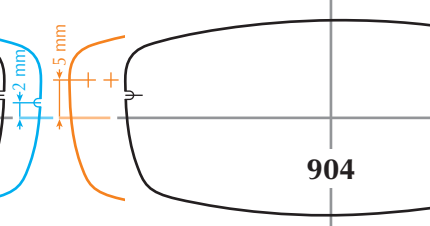
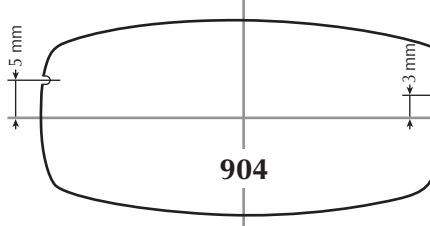
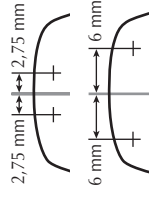
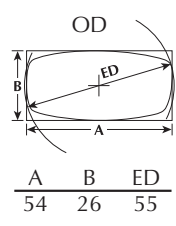

Toutes ces informations sont communiquées à titre indicatif et doivent être adaptées à la forme du nez du porteur.  
All infos provided must be adapted to shape and size of the patient's nose.

⚠ Attention : certaines imprimantes peuvent ne pas reproduire ce document à l'échelle exacte.  
Note: some printers may not duplicate this document at the correct scale.



M-22	M-21	M-503	M-0/OP/1/2/3/4/5	Pont traditionnel Traditional bridge	Pont W nu W bridge bare	Pont M-8 / M-5C M-8 / M-5C bridge	M-5C / M-8 / 57C 58C / 59C / 60C / 61C 62C / 63C / 64C / 81 501C / 502C
	M-25	M-505	7 / 52 / 53 / 56 / 57 58 / 59 / 60 / 61 / 62 63 / 64 / 71 / 501 / 502	Pont W avec selle clipsée W bridge with clipped saddle ou Pont P/P Bridge			

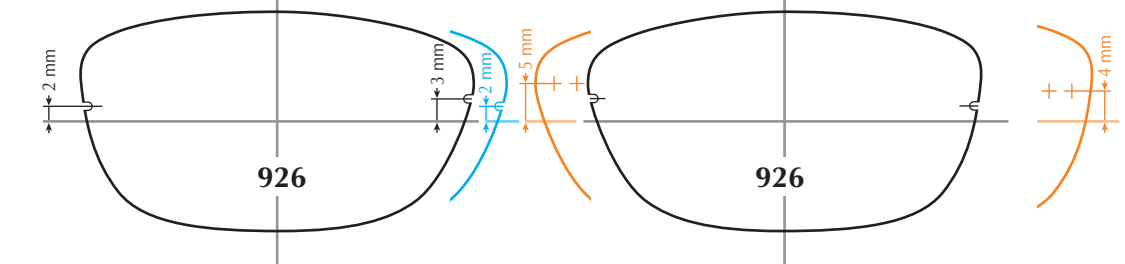
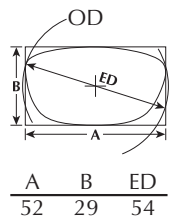
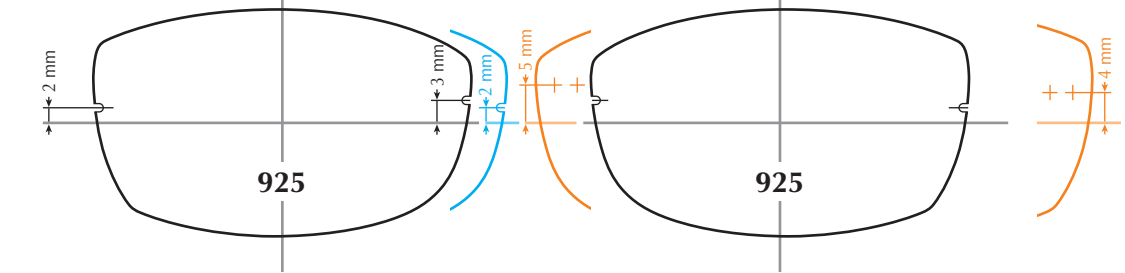
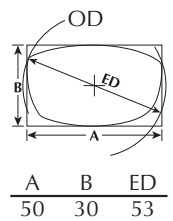
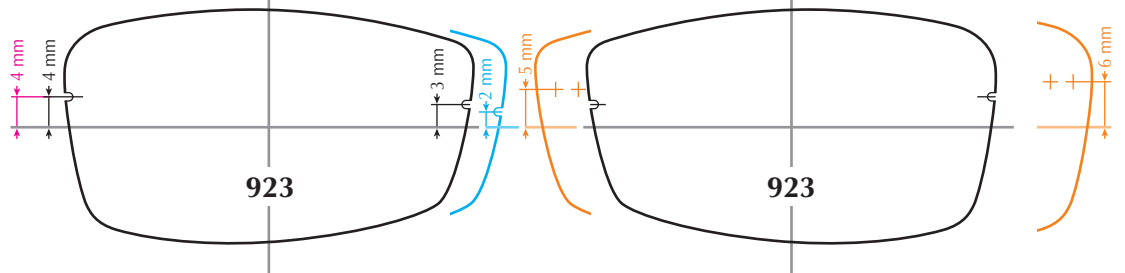
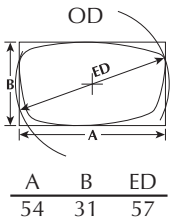
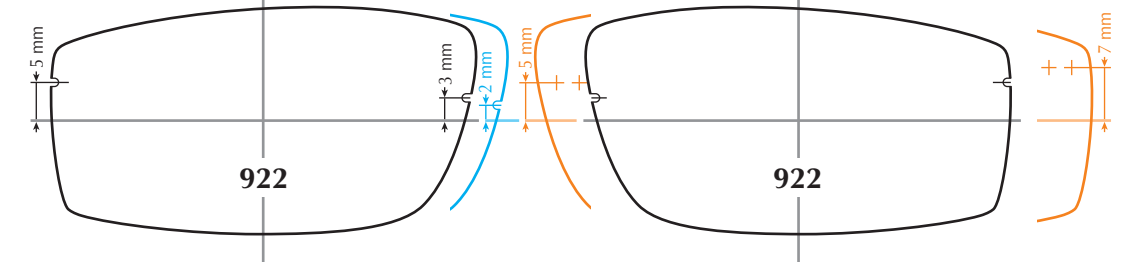
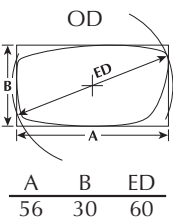
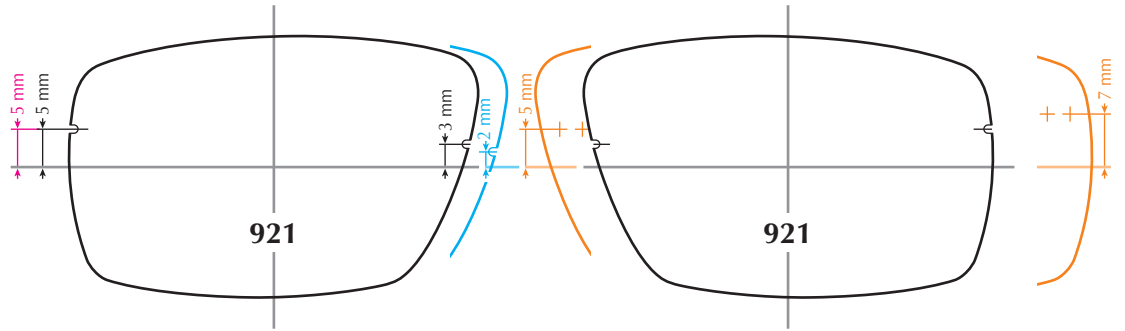
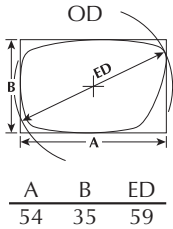

Toutes ces informations sont communiquées à titre indicatif et doivent être adaptées à la forme du nez du porteur.  
All infos provided must be adapted to shape and size of the patient's nose.

⚠ Attention : certaines imprimantes peuvent ne pas reproduire ce document à l'échelle exacte.  
Note: some printers may not duplicate this document at the correct scale.



M-22	M-21	M-503	M-0/OP/1/2/3/4/5	Pont traditionnel Traditional bridge	Pont W nu W bridge bare	Pont M-8 / M-5C M-8 / M-5C bridge	M-5C / M-8 / 57C 58C / 59C / 60C / 61C 62C / 63C / 64C / 81 501C / 502C
M-25	M-505	7 / 52 / 53 / 56 / 57 58 / 59 / 60 / 61 / 62 63 / 64 / 71 / 501 / 502	Pont W avec selle clipsée W bridge with clipped saddle ou Pont P/P Bridge				

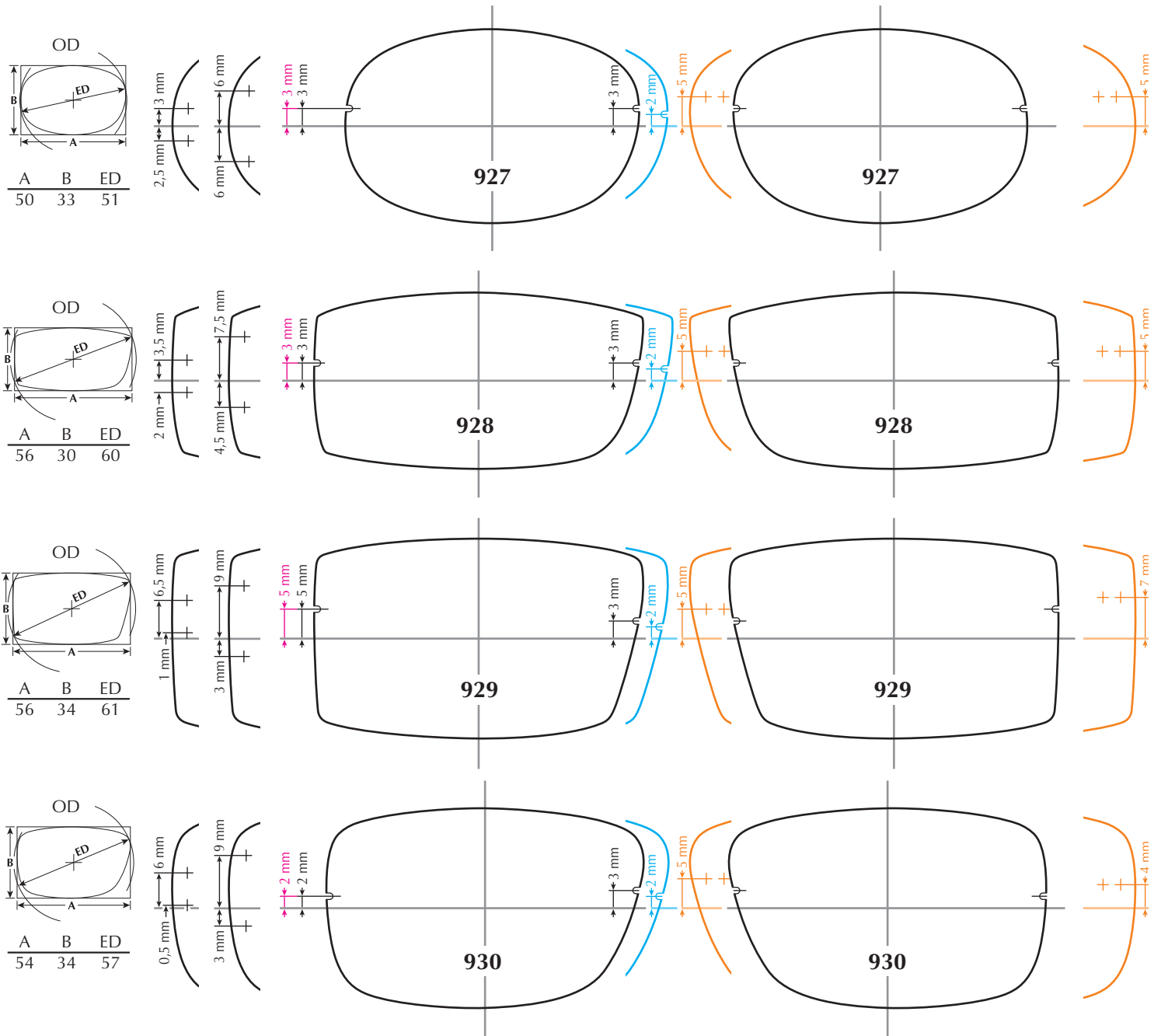

Toutes ces informations sont communiquées à titre indicatif et doivent être adaptées à la forme du nez du porteur.  
All infos provided must be adapted to shape and size of the patient's nose.

⚠ Attention : certaines imprimantes peuvent ne pas reproduire ce document à l'échelle exacte.  
Note: some printers may not duplicate this document at the correct scale.

